

Speedfit[®]

THE PUSH-FIT SOLUTION FOR PLUMBING & HEATING SYSTEMS

Speedfit Fittings are suitable for use with copper pipe.



Includes this NEW addition:



UK Trade Guide

January 2017

Worldwide Connections

The John Guest Group has a long established reputation as a world leading manufacturer of push-fit fittings, tube and other fluid control products. A reputation built on producing consistently high quality products with an ongoing commitment to value engineering and product development.



Quality Manufacture

A commitment to quality is at the heart of the John Guest Philosophy.

The strictest control is maintained by virtue of the fact that design and manufacture is carried out in modern purpose built manufacturing centres in West London and at Maidenhead in Berkshire.

Maintaining control over the whole process from initial tool design and tool making through to final assembly and testing ensuring that only products of the highest quality are produced.

The company believe it is this commitment to quality that has led to it receiving prestigious awards from many of the world's leading testing and approvals organisations.

John Guest is a preferred supplier to many international companies.



British Gas Service



GUARANTEE

As a result of long term test programmes and rigorous quality standards, John Guest Speedfit Limited offer a 25 year guarantee against the defects in materials or manufacturing of 'PEM', 'PSE' and 'SFM' Range Plumbing Fittings and Speedfit Barrier Pipe manufactured by John Guest.

John Guest Underfloor Heating Products, Brass Manifolds and Radiator Valves, which should be installed and maintained in accordance with our recommendations, carry a 2 year guarantee from date of delivery against defects in materials and manufacture. JG Aura heating controls carry a 5 year guarantee.

John Guest Plumbing and Heating Products are for use with normal UK domestic plumbing and heating systems and supplied in accordance with our Conditions of Sale.



Contents

The Push-fit Solution <i>Pages 3 to 6</i>		System Connections <i>Pages 27 to 32</i>	
How Speedfit Works <i>Pages 7 and 10</i>		JG Speedfit Underfloor Heating and Speedfit Support <i>Page 33</i>	
White Push-fit Fittings <i>Pages 11 and 12</i>		Manifolds and Fixing Systems <i>Page 34</i>	
Brass Fittings and Valves <i>Pages 13 and 14</i>		JG Aura Wireless Underfloor Heating Controls <i>Page 35</i>	
Pipe and Accessories Layflat Barrier Pipe <i>Pages 15 and 16</i>		JG Aura Wireless Thermostatic Radiator Valve <i>Page 36</i>	
Other Plumbing Fittings <i>Page 16</i>		JG Aura 230v Underfloor Heating Controls <i>Page 36</i>	
Braided and White Flexi Hoses <i>Pages 17 and 18</i>		JG Aura App <i>Page 36</i>	
Merchandising <i>Pages 19 and 20</i>		Room Packs and Underfloor Heating Spare Parts <i>Page 37</i>	
Pre-Packed Products <i>Pages 21 to 24</i>		Technical Checklist, Numerical Listing and Conditions of Sale <i>Pages 38 to 41</i>	
Speedfit Blue Fittings for MDPE <i>Pages 25 and 26</i>			

THE PUSH-FIT SOLUTION FOR PLUMBING AND HEATING SYSTEMS

JG Speedfit is a push-fit system suitable for the plumbing of domestic hot and cold water services and central heating applications, including pressurised and combi systems.

The System is approved by the Water Regulations Advisory Scheme. Speedfit 'PEM' fittings and PEX and Polybutylene Barrier Pipe are Kitemarked to BS7291 Parts 1, 2 and 3 Class S Licence No KM39767.

Performance specifications are well within those required for most central heating and water supply systems including:

- Mains fed and indirect cold water systems
- Vented and unvented hot water systems
- Vented central heating systems
- Sealed central heating systems provided temperatures and pressures comply with BS7291 Parts 1, 2 and 3 Class S
- Underfloor heating

Extensive tests have shown that Speedfit products will withstand temperatures and pressures well in excess of normal working conditions.

Speedfit should be installed to conform with good plumbing practice.

Speedfit should not be used for gas, fuel oil or compressed air applications.



Speedfit Support's national team of technical engineers is available to help you get the best from your Speedfit System, be it assistance or advice.

Their service includes a free underfloor heating estimate, onsite installation advice, a technical helpline and a free CAD design service.

Technical Help Desk: 01895 425333
8am to 5pm Monday through Friday



Instant Estimate



Free Design with Quote



Support On Your Doorstep



Technical Helpline



Install Videos & Guides

SPECIAL APPLICATIONS

Boats. The flexibility of the Speedfit System ensures it can be cabled easily around the interior and hidden from view.

Caravans. Speedfit is ideal for caravan installations due to its flexibility and its resistance to corrosion and freezing.

Exhibitions. The unique ability of the Speedfit System to be easily demounted and reused, together with its flexibility, makes Speedfit ideal for this application.

Agricultural and Horticultural. Speedfit has many applications in agricultural and horticultural environments.

Portable Buildings (site cabins, toilets). As with caravans, Speedfit is well suited to this application.

WORKING TEMPERATURES AND PRESSURES

Application	Usual working temperature, °C	Maximum working temperature, °C	Maximum working pressure, bar
Cold Water (indirect and direct mains)	20	20	12
Central Heating	82	105, short term malfunction at 114	3
Hot Water (including unvented cylinders)	65	95	6

Speedfit fittings suitable for central heating systems can withstand temperatures up to 114°C intermittently for short periods.

Speedfit fittings shown as not suitable for central heating systems are used primarily on the domestic hot and cold water system accepting temperatures of up to 65°C.

HANDLING FITTINGS AND PIPE

Ensure fittings and pipe are kept clean at all times by keeping them in bags and boxes provided.

Do not empty Speedfit Products onto the floor area.

Ensure internal 'O' Ring seals are kept free from dirt and debris.

PRODUCT SELECTION AND INSTALLATION

John Guest fittings and related products are specifically designed and manufactured by John Guest to the Technical Specifications set out in the John Guest Product Catalogues.

All John Guest fittings and related products should be selected, used and maintained in accordance with these Technical Specifications.

It is the customer's / user's responsibility to ensure that John Guest fittings and related products are suitable for their intended applications, are properly installed and maintained and are used in accordance with the Technical Specifications. It is also the customer's / user's responsibility to provide it's own customers with any relevant technical information about John Guest products it supplies them.

John Guest produce a Push-fit system of pipe and fittings for compressed air situations. See separate literature for details.

MAKING A GOOD CONNECTION

PREPARE THE PIPE

Fittings and pipe should be kept clean bagged and undamaged before use.

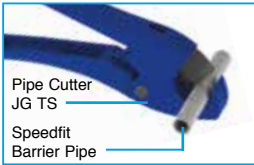

Ensure the pipe is free of score marks. Cut the pipe square. When using Speedfit Barrier Pipe cut along an insertion mark. We recommend the use of JG Pipe Cutters.



To prevent damage to the 'O' ring remove all burrs and sharp edges. When connecting Speedfit Pipe use a Superseal Pipe Insert or a Standard Speedfit Pipe Insert. A twisting motion will aid insertion. The insert should only be used with Speedfit Pipe.

TWIST AND LOCK FITTINGS

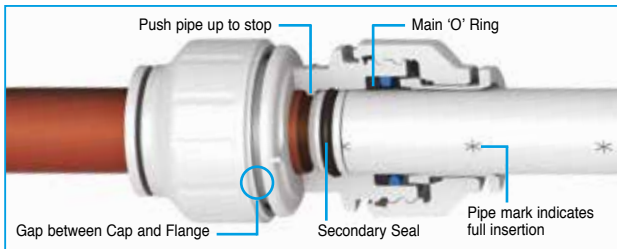

The fitting should be in the 'unlocked' position, this is shown with a small gap between the screwcap and the body flange.

Push the pipe fully into the fitting, up to the pipe stop. If the Speedfit Pipe has been cut correctly the insertion mark on the pipe will be level with the collet head. The 'O' ring on the Superseal Pipe Insert provides a secondary seal against the bore of the fitting. A good connection has been made.



If you are not using collet clips, ensure that the screwcaps are in the locked position. Pull to check it is secure. It is good practice to test the system prior to leaving the site or before use. Our recommended test procedure is shown in our Technical Checklist.

ADDED BENEFIT OF TWIST AND LOCK

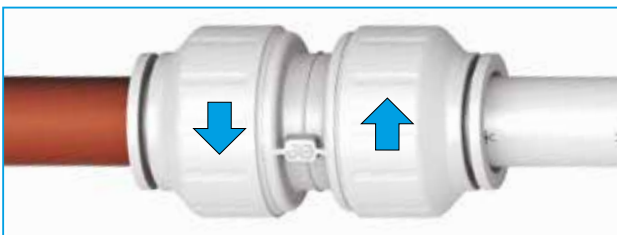

Twist the screwcap until it touches the body flange. This increases the 'O' ring seal around the pipe and locks the pipe into position.

STANDARD SPEEDFIT FITTINGS

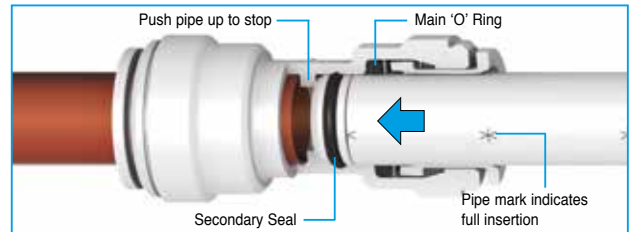

Standard Speedfit connections are made in the same way as Twist and Lock.

Push Pipe up to Pipe Stop. If the Speedfit Pipe has been cut correctly the insertion mark on the pipe will be level with the collet head.

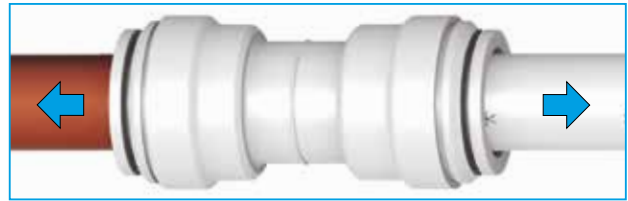

Pull to check connection is secure and test the system. Our recommended test procedure is shown in our Technical Checklist on page 31.

TO DISCONNECT

Ensure that the system is depressurised.

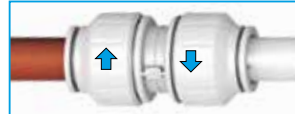

The screwcap on Twist and Lock Fittings will need to be turned back to the unlocked position.



For both Twist and Lock and Standard fittings, push the collet square against the face of the fitting by using fingers or with the help of our collet release tool.

With the collet held in position the pipe can be removed. The fitting can be used again without the need for replacement parts.

WHAT NOT TO DO

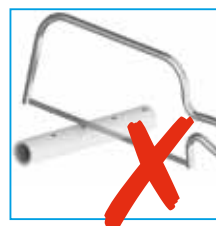

Don't use hacksaws to cut the pipe or leave burrs on the end of the pipe.

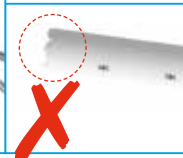

Don't use damaged or scored pipe. Score marks can cause leaks passed the 'O' Ring.

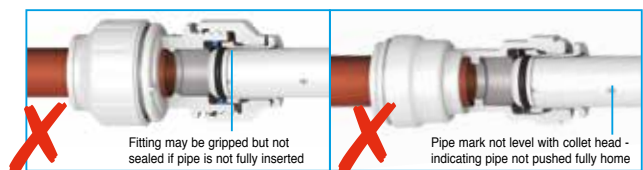

Don't forget to push the pipe fully into the fitting, past both the collet (gripper) and the 'O' ring.

Do not insert fingers into the fitting as the stainless steel teeth may cause injury.

Remember to pressure test the completed installation according to the recommendations in our Technical Checklist.

PIPE STOP DISTANCES

Stops are located at the following distances from the end of the fitting:

Size	10mm	15mm	22mm	28mm
Stop Distance	20mm	30mm	35mm	44mm

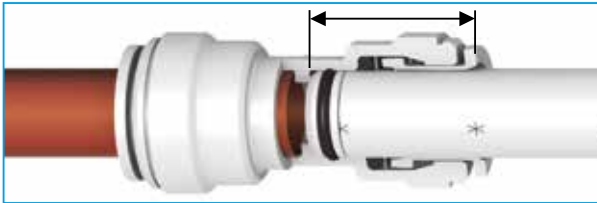

COLLET COVERS AND COLLET CLIPS

Use a collet cover or collet clip to provide added security against pipe disconnection, e.g. the fitting coming into contact with rigid surfaces and behind dry-lining walls.

Collet covers for use with standard Speedfit fittings, are available in white or in red or blue to allow colour coding of pipes.

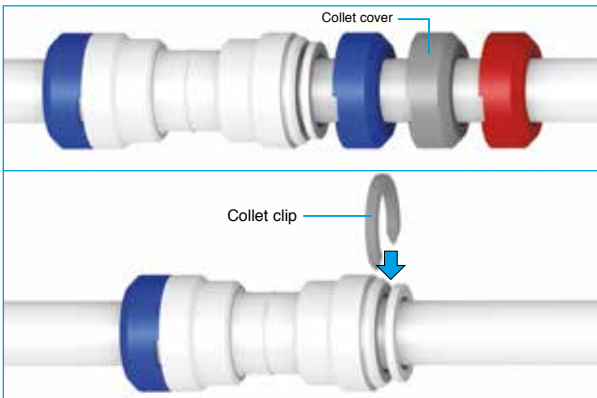

White or grey collet clips are used with standard fittings to prevent accidental pipe disconnection.

Red or Blue collet clips provide colour coding of pipe on Twist and Lock fittings. They are not designed to prevent accidental release and should be fitted when the fitting is in the locked position.



RELEASE AID

The action of pressure in a system could increase the grip of the collet. The release aid allows a firmer grip on the collet whilst removing the pipe.



STOP END

The unique feature of the Speedfit Concept, the ability to disconnect the fitting should you want to, means the Speedfit Stop End not only provides a permanent leakproof seal, but can be readily removed to allow work to restart or to allow an extension to a system. Thus, the fitting is especially useful to allow water to be turned back on, overnight for instance, or if a job has to be interrupted for another reason.



Stop ends are also useful when pressure testing a system before appliances are connected.

STEM ELBOW



Designed to simplify pipe connection in restricted spaces. The Speedfit Stem Elbow provides an instant swivel fitting so pipe can be orientated in any direction.

A special 10mm version gives a neat connection from concealed plumbing to a radiator.

SERVICE VALVES

The Speedfit range of brass chromium plated service valves can be used on both hot and cold water services and central heating. Push-fit connections mean much reduced installation time, especially in confined spaces.



Speedfit x Speedfit Mechanism twists out of sight

The valves, in 10 to 22mm, have a 1/4 turn open/close mechanism operated by a screwdriver slot or a lever.

The ability of Speedfit products to twist whilst in situ allows the screwdriver slot operating valve to be turned out of sight, helping to avoid unauthorised tampering.

FLEXI HOSES

Manufactured to a quality you would expect from Speedfit, our range of Flexi Hoses has nearly 50 different patterns. A special pattern has been designed to help the installation of monoblocs, each hose in a pair having a different spanner location to ease connection of the threaded end into the monoblocs inlets.



Flexi Hoses are listed on pages 17 and 18.

TAP CONNECTORS

Speedfit manufacturer a wide range of connectors including conventional straight and bent tap connectors.



The range also offers a special and unique Tap Connector that only requires a simple hand tightening to connect up a terminal tap, mixer or a float valve. An integral seal within the fitting avoids the need for further sealant. The connectors are useful when replacing existing brassware or in other confined spaces.

Coupling up to a supply is easy. The pipe is simply pushed home into the Speedfit connection and is instantly secured, without the need for specialist tools.

SPEEDFIT MANIFOLD

Speedfit have introduced an innovative 22mm x 10mm 4 Way Manifold. Departing from the usual manifold design, this new product has 4 in-line 10mm outlets, offering a neater envelope size and therefore a much smaller installation space.

Other benefits include better flow characteristics and a more even distribution of hot water.

The 22mm and 10mm Speedfit Push-fit connections make for a fast and easy installation, even in confined spaces.

Whilst designed as heating product, the manifold can also be used in a mains pressure hot or cold domestic plumbing system, to feed bathroom or kitchen taps and mixers. This allows for a more efficient installation as every terminal fitting has its own dedicated supply.



APPLIANCE TAPS

The Speedfit Range includes an Appliance Tap for the permanent connection of washing machines and dishwashers, thus enabling complete water isolation to the appliances.



A simple push-fit connection of the supply pipe and a plastic thread on the outlet to marry well with the plastic thread on the hose means the Speedfit Appliance Tap is very easy to install. The large round handle is easy to grip and turn.

SUPERSEAL PIPE INSERT

The Superseal Pipe Insert has been developed to be used with Speedfit Barrier Pipe and Speedfit Fittings to provide an extra line of defence when installing a Speedfit Push-fit System.

The insert has its own 'O' ring which, together with a stem sliding within the inside diameter of the pipe gives a secondary seal against the inside of the fitting.



The Speedfit Connection, when made with the insert, has a number of design features.

Sliding the stem of the insert into the pipe gives greater compression of the main 'O' ring on the pipe and greater rigidity of the length of pipe within the fitting, reducing the chance of leaks if a side load is applied.

A connection is easier to make because the head of the insert has been designed for ease of insertion.

Superseal Inserts are listed on page 15.

HOW SPEEDFIT WORKS

The JG Speedfit system uses a simple push-fit action meaning that there is no flux, flames or mess. All fittings have a grip then seal construction, made up of a collet with stainless steel teeth to grip an 'O' ring to provide a permanent leak proof seal.

The additional benefit of 'Twist and Lock' is that a twist of a screwcap locks the pipe in position and provides increased compression on the 'O' ring for even greater security. With plastic pipe available in straight lengths or coils, the flexible system will ensure a fast, simple and reliable installation.

Features

- Truly demountable without damage to pipe or fitting
- Grip and seal connection
- Superseal Insert gives secondary seal
- Reduced pipe insertion force
- Lightweight and easy to handle on site

Why Speedfit?

- Installation time reduced by up to 40%
- Pipe flexibility permits the cabling of pipe through less accessible areas
- No risk of fire or flames from a blowtorch
- Easier to work in confined places
- A permanent leak-proof connection
- Corrosion free
- No scale build up
- Lower thermal diffusivity maintains safer surface temperature
- Pipe elasticity can reduce the possibility of bursting under freezing conditions
- Lead free and non toxic
- Less noise from water flow and expansion / contraction
- Long pipe lengths reduce the number of fittings required



Speedfit® Technology

WITH YOU EVERYDAY



TELECOM CONNECTIONS

Connecting Ultra Fast Broadband Cables

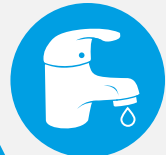

PLUMBING & HEATING

UK Market Leader in Plastic Plumbing & Heating Systems



PUBS & BARS

Connecting Beer Lines in 95% of Bars in the UK



AUTOMOTIVE

Fuel & Brake Line Connections for Luxury Car Markets



PURE WATER

World Leader in Water Filtration Connection Technology



COMPRESSED AIR

Connecting Air & Pneumatic Tubing in Factories



DRINKS DISPENSE

Wide Range of Connectors for Drinks & Coffee Dispensers



Plastic Innovation



Engineering Excellence



Speedfit[®] Technology



Speedfit[®] Technology

Speedfit Technology is built into the DNA of all our push-fit fittings. The distinctive appeal lies within its flexibility of application, high reliability of performance, longevity of service and suitability to a wide variety of industries.

The core technology behind a JG Speedfit plumbing fitting is the same concept incorporated in all John Guest fittings serving the needs of industries as diverse as drinks dispense, pneumatics, compressed air, water purification, drinks vending and telecommunications.





Twist and Lock Cap.

Increases compression on the 'O' ring seal around the pipe and locks the pipe into position.

Pipe Stop.

Push the pipe all the way onto the fitting to ensure full insertion.

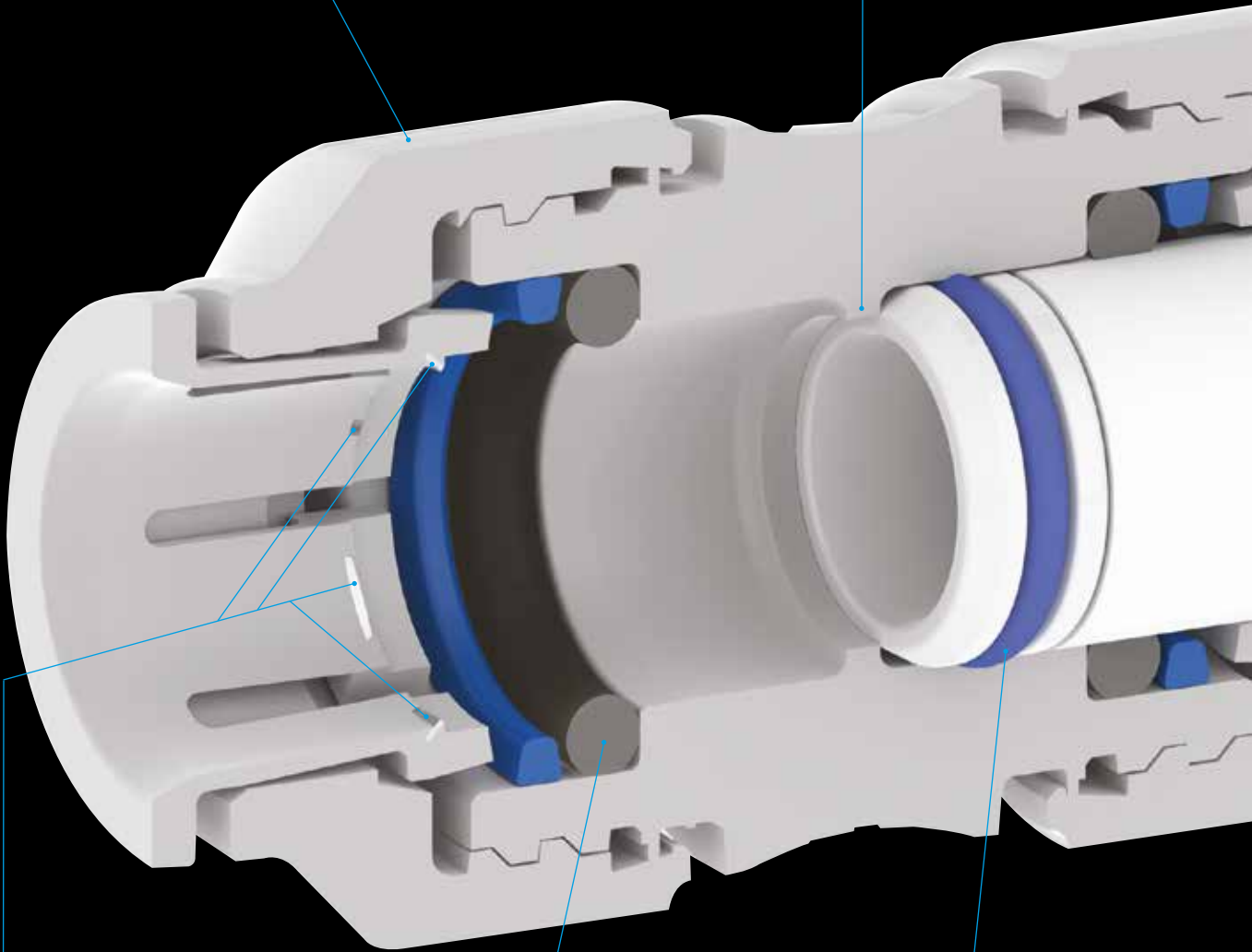

Stainless Steel Teeth.

Provides a firm grip on plastic or copper pipe.

Main 'O' Ring Seal.

Ensures a permanent leak-proof connection.

Superseal 'O' Ring.

Pipe insert gives a secondary seal.

WHITE PLUMBING FITTINGS



EQUAL STRAIGHT CONNECTOR



PART No.	SIZE MM	BAG QTY	SMALL BOX	LARGE BOX
PEM0410W	10	10	150	
PEM0415W	15	10	60	400
PEM0422W	22	5	30	200
PEM0428W	28	2	10	

Suitable for central heating systems.

REDUCING STRAIGHT COUPLER



PART No.	SIZE MM	BAG QTY	BOX QTY
PEM201510W	15 x 10	10	80
PEM202215W	22 x 15	5	40

Suitable for central heating systems.

PE-COPPER COUPLER



Used to connect PE Pipe to copper or Speedfit Plumbing Pipe. Must not be buried directly into ground, soil, concrete or other substrates.

PART No.	SIZE MM	BAG QTY	BOX QTY
UG601B	20 x 15	1	150
UG603B	25 x 15	1	100
UG602B	25 x 22	1	80
UG604B	32 x 28	1	60

Cold water only

• Taken from the range of Speedfit Fittings for Cold Water Services. See separate section for details and Technical Specification.

EQUAL ELBOW



PART No.	SIZE MM	BAG QTY	SMALL BOX	LARGE BOX
PEM0310W	10	10	150	1000
PEM0315W	15	10	50	400
PEM0322W	22	5	25	150
PEM0328W	28	2	10	

Suitable for central heating systems.

REDUCING ELBOW



PART No.	SIZE MM	BAG QTY	BOX QTY
PEM211510W	15 x 10	10	50
PEM212215W	22 x 15	5	40

Suitable for central heating systems.

STEM ELBOW



Provides a swivel type connection.

PART No.	PIPE MM	STEM MM	BAG QTY	SMALL BOX	LARGE BOX
PEM221010W	10	10	10	200	
PEM221015W	10	15	10	150	
PEM221515W	15	15	10	80	500
PEM222222W	22	22	5	30	

Suitable for central heating systems.

Please note a Collet Cover cannot be used on a Speedfit end assembled with the stem of a 22mm Stem Elbow.

135° STEM ELBOW



PART No.	SIZE MM	BAG QTY	BOX QTY
PEM571515W	15	10	80
PEM572222W	22	5	30

Suitable for central heating systems.

EQUAL TEE



PART No.	SIZE MM	BAG QTY	SMALL BOX	LARGE BOX
PEM0210W	10	10	100	
PEM0215W	15	5	40	250
PEM0222W	22	5	15	100
PEM0228W	28	2	8	

Suitable for central heating systems.

REDUCING TEE



Sizes listed as follows.



PART No.	SIZE MM	BAG QTY	SMALL BOX	LARGE BOX
PEM3015BW	15x10x10	10	60	
PEM3015AW	15x15x10	5	40	
PEM3022CW	15x15x22	5	25	
PEM3022BW	22x15x15	5	25	150
PEM3022DW	22x15x22	5	15	150
PEM302210AW	22x22x10	5	20	
PEM3022AW	22x22x15	5	15	150
PEM3028BW	28x22x22	2	10	
PEM3028DW	28x22x28	2	10	
PEM302810AW	28x28x10	2	10	
PEM302815AW	28x28x15	2	10	
PEM3028AW	28x28x22	2	10	

Suitable for central heating systems.

STEM TEE



Sizes listed as follows.

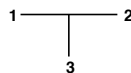

PART No.	SIZE MM	BAG QTY	BOX QTY
PEM532210W	22x22x10	5	30
PEM532215W	22x22x15	5	25

Suitable for central heating systems.

FEMALE COUPLER - TAP CONNECTOR



Requires hand tightening only.

PART No.	SIZE MM X BSP	BAG QTY	SMALL BOX	LARGE BOX
PSE3210W	10 x 1/2"	10	150	
PSE3201W	15 x 1/2"	10	100	600
PSE3203W	15 x 3/4"	5	70	
PSE3202W	22 x 3/4"	5	50	400

Suitable for central heating systems.

Note: Plastic threads are not as strong as metal threads. For torque figures see Technical Checklist.

STRAIGHT TAP CONNECTOR



PART No.	SIZE MM X BSP	BAG QTY	BOX QTY
PEMSTC1014	10 x 1/2"	10	150
PEMSTC1514	15 x 1/2"	5	50
PEMSTC1516	15 x 3/4"	5	50
PEMSTC2216	22 x 3/4"	5	40

Suitable for central heating systems.

With brass swivel nut and sealing washer. For torque figures see Technical Checklist.

BENT TAP CONNECTOR



PART No.	SIZE MM x BSP	BAG QTY	BOX QTY
PEMBTC1014	10 x 1/2"	10	150
PEMBTC1514	15 x 1/2"	5	50

Suitable for central heating systems.

With brass swivel nut and sealing washer.
For torque figures see Technical Checklist.

STOP END



PART No.	SIZE MM	BAG QTY	SMALL BOX	LARGE BOX
PSE4610W	10	10	300	
PSE4615W	15	10	200	1000
PSE4622W	22	5	80	500
PSE4628W	28	5	50	

Suitable for central heating systems.

REDUCER



PART No.	SIZE MM	BAG QTY	SMALL BOX	LARGE BOX
PEM061510W	15 x 10	10	150	1000
PEM062215W	22 x 15	10	70	
PEM062815W	28 x 15	5	40	
PEM062822W	28 x 22	5	30	

Suitable for central heating systems.

TANK CONNECTOR



Requires hand
tightening only.

Maximum wall
thickness
of tank = 4mm.

PART No.	SIZE MM	BAG QTY	BOX QTY
CM0715S	15	10	60
CM0722S	22	5	20
CM0728S	28	1	10

Suitable for cold water tanks only.

PLUG



PART No.	SIZE MM	BAG QTY	BOX QTY
PL10	10	10	500
PL15	15	10	250
PL22	22	10	100
PL28	28	10	50

Suitable for central heating systems.

PIPE REPAIR KIT



PART No.	SIZE MM	BAG QTY	BOX QTY
15RKP	15	1	80
22RKP	22	1	50

Suitable for central heating systems.

Provides a simple way of repair on a rigid pipe run.

Remove a damaged section of pipe and replace with a repair kit

SLIP TEE CONNECTOR



PART No.	SIZE MM	BAG QTY	BOX QTY
15TKP	15	1	80
22TKP	22	1	40

Suitable for central heating systems.

Provides a simple way to
break into an existing pipe run

PLASTIC BACK PLATE ELBOW



PART No.	SIZE MM x BSP	BAG QTY	BOX QTY
15PWB	15 x 1/2"	1	25

Hot and cold water only, 65°C maximum.
Protect from sunlight and frost.

WING BACK ELBOW



PART No.	SIZE MM x BSPT	BAG QTY	BOX QTY
UGPW1514	15 x 1/2"	1	150

Cold water only

BULKHEAD ELBOW



PART No.	SIZE MM x BSPT	BAG QTY	BOX QTY
CM551516W	15mm x 3/4"	5	25

Not suitable for central heating systems.
Hot and cold water only, 65°C maximum.

2 WAY DIVIDER



PART No.	SIZE MM	BAG QTY	BOX QTY
CM2315W	15	5	50

Not suitable for central heating systems.

4 WAY MANIFOLD



PART No.	SIZE MM	BAG QTY	BOX QTY
SFM512210E	22 x 10	5	30

Suitable for central heating systems.

4 PORT RAIL MANIFOLD



PART No.	SIZE MM	BOX QTY
SFM522210E	22 x 10	10
SFM522215E	22 x 15	10

Suitable for central heating systems.



FOR PIPE SEE PAGE 15

BRASS FITTINGS



BRASS MALE COUPLER



PART No.	SIZE MM X BSPT	BAG QTY	Box QTY
MW011504N	15mm x 1/2" BSPT	5	100
MW012206N	22mm x 3/4" BSPT	5	50
MW012808N	28mm x 1" BSPT	5	20

PART No.	SIZE MM X BSP	BAG QTY	Box QTY
10MC (1/2)	10mm x 1/2" BSP	5	100
15MC (1/2)	15mm x 1/2" BSP	5	100
22MC (3/4)	22mm x 3/4" BSP	5	50
MW012818N	28mm x 1" BSP	5	20

Suitable for central heating systems.
Manufactured in DZR Brass.

BRASS FEMALE COUPLER



PART No.	SIZE MM X BSP	BAG QTY	Box QTY
MW451514N	15 x 1/2"	5	50
MW452216N	22 x 3/4"	5	50

Suitable for central heating systems.
Manufactured in DZR Brass.

BRASS BACK PLATE ELBOW



PART No.	SIZE MM X BSP	BAG QTY	Box QTY
15WB	15 x 1/2"	1	20
22WB	22 x 3/4"	1	10

Manufactured in DZR Brass.
Suitable for central heating systems.

SHORT VERSION

15WB2	15 x 1/2"	1	25
-------	-----------	---	----

Manufactured in Brass.
Suitable for central heating systems.

BRASS MALE STEM ADAPTOR



Converts Speedfit to male thread

PART No.	SIZE MM X BSPT	BAG QTY	Box QTY
MW051504N	15 x 1/2"	5	100
MW052206N	22 x 3/4"	5	50
MW052818N	28 x 1" BSP	10	20

Suitable for central heating systems.
Manufactured in DZR Brass.

BRASS FEMALE STEM ADAPTOR



Converts Speedfit to female thread

PART No.	SIZE MM X BSP	BAG QTY	Box QTY
MW501514N	15 x 1/2"	5	50
MW502216N	22 x 3/4"	5	50

Suitable for central heating systems.
Manufactured in DZR Brass.

BRASS FEMALE CYLINDER ADAPTOR



PART No.	SIZE MM X BSP	BAG QTY	Box QTY
22CFA	22 x 1"	5	50

Suitable for central heating systems.
Manufactured in DZR Brass.

BRASS MALE CYLINDER ADAPTOR



PART No.	SIZE MM X BSP	BAG QTY	Box QTY
22CMA	22 x 1"	5	50

Suitable for central heating systems.
Manufactured in DZR Brass.

VALVES

1/4 Turn Valves. These valves have been designed to allow temporary servicing of downstream equipment and must only be used in the fully open or fully closed position.

Do Not use these Valves:

- In a partially open position to control flow.
- To provide a permanent termination.
- Without tubing assembled or plugged (or threaded connections sealed).
- As a tap or "faucet".

1/4 Turn Valves are indicated by this marker '●'

STOP VALVE



PART No.	SIZE MM	BAG QTY	Box QTY
15STV	15	1	15
22STV	22	1	5

Not suitable for central heating systems.
Hot and Cold water only, 65°C maximum.

APPLIANCE TAP ●



PART No.	SIZE MM X BSP	BAG QTY	Box QTY
15APT	15 x 3/4"	5	40

Not suitable for central heating systems.
For maximum torque figures on plastic thread, please see Technical Checklist.

APPLIANCE TEE ●



PART No.	SIZE MM X BSP	BAG QTY	Box QTY
15APT2	15 x 3/4"	5	30

Not suitable for central heating systems.
Hot and Cold water only, 65°C maximum.

EMERGENCY SHUT OFF TAP ●



PART No.	SIZE MM	BAG QTY	Box QTY
15ESOT	15	5	40

Not suitable for central heating systems.
Hot and Cold water only, 65°C maximum.

ANGLE STOP VALVE ●



PART No.	SIZE MM X INCH	PACK QTY	Box QTY
ASV3	15 x 1/4"	1	30
ASV4	15 x 3/8"	1	25

Not suitable for central heating systems.
Hot and Cold water only, 65°C maximum.
Provides an inline connection with shut off and check valve protection for the easy installation of water coolers, filtration equipment and vending machines.

DOUBLE CHECK VALVE



PART No.	SIZE MM	BAG QTY	Box QTY
15DCV	15	5	50

Not suitable for central heating systems.
Hot and Cold water only, 65°C maximum.

DOUBLE CHECK SERVICE VALVE



PART No.	SIZE MM	BAG QTY	BOX QTY
15DCSV	15	1	20

Not suitable for central heating systems.
Hot and Cold water only, 65°C maximum.

PLASTIC SERVICE VALVE



PART No.	SIZE MM	BAG QTY	BOX QTY
15SV	15	5	50
22SV	22	5	25

Not suitable for central heating systems.
Hot and Cold water only, 65°C maximum.

PLASTIC BALL VALVE

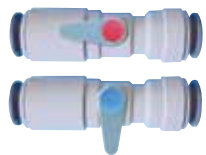

PART No.	SIZE MM	PACK QTY	BOX QTY
15SV-H	15	1	40
22SV-H	22	1	20

Not suitable for central heating systems.
Each valve has red and blue indices.

PLASTIC SERVICE VALVE WITH TAP CONNECTOR



PART No.	SIZE MM X BSP	BAG QTY	BOX QTY
15SVSTC	15 x 1/2"	5	50
15SVSTC-W	15 x 1/2"	5	50

Not suitable for central heating systems.
Hot and Cold water only, 65°C maximum.

PLASTIC ANGLE SERVICE VALVE WITH TAP CONNECTOR



PART No.	SIZE MM X BSP	BAG QTY	BOX QTY
15SVBTC	15 x 1/2"	5	50
15SVBTC-W	15 x 1/2"	5	50

Not suitable for central heating systems.
Hot and Cold water only, 65°C maximum.

BRASS SERVICE VALVE



PART No.	SIZE MM	PACK QTY	BOX QTY
15HSV-BRASS	15	2	20

Suitable for central heating systems.

BRASS CHROME PLATED SERVICE VALVE



PART No.	SIZE MM	PACK QTY	BOX QTY
10HSV	10	1	30
15HSV	15	2	20
22HSV	22	1	8

Suitable for central heating systems.

BRASS CHROME PLATED SERVICE VALVE WITH TAP CONNECTOR



PART No.	SIZE MM X BSP	PACK QTY	BOX QTY
15PTSV	15 x 1/2"	2	20
22PTSV	22 x 3/4"	1	8

Suitable for central heating systems.

BRASS CHROME PLATED BALL VALVE

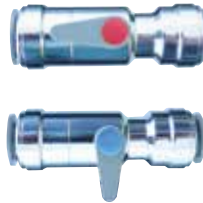

PART No.	SIZE MM	PACK QTY	BOX QTY
10BV	10	1	30
15BV	15	1	20
22BV	22	1	15

Suitable for central heating systems.

Each valve has red and blue indices.

BRASS MANIFOLD



PART No.	DESCRIPTION	SIZE BSP X MM	PACK QTY	BOX QTY
JGMAN2	2 Port	3/4" x 15	1	30
JGMAN3	3 Port	3/4" x 15	1	25
JGMAN4	4 Port	3/4" x 15	1	20

Blanking plug supplied with each manifold. Each manifold supplied with reversible red and blue discs.

Not Suitable for central heating systems.

BRASS STOP VALVE



PART No.	SIZE MM X BSP	BAG QTY	BOX QTY
15BSC	15	1	10

Only suitable for central heating systems.
Manufactured in DZR Brass.

BRASS DRAIN COCK



PART No.	SIZE MM	BAG QTY	BOX QTY
15BDC	15	5	50

Suitable for central heating systems.
Manufactured in DZR Brass.

Speedfit Drain Cocks cannot be used where collet covers are fitted. They can be used with a standard fitting fitted with a collet clip.

THERMOSTATIC RADIATOR VALVE



PART No.	SIZE MM	PACK QTY	BOX QTY
JGTHRAD15	15	1	10

LOCKSHIELD RADIATOR VALVE



PART No.	SIZE MM	PACK QTY	BOX QTY
JGRAD15	15	1	20



Layflat Pipe

Lays Flat - Stays Flat - Ultra Flexible

JG LAYFLAT® POLYBUTYLENE BARRIER PIPE



Coils. The pipe is made from a soft material with little memory ensuring a flexible system. It has an inner barrier to stop the ingress of atmosphere. British Gas accepted for water pipe in vented and sealed central heating systems.

PART NO.	SIZE MM X M	PACK QTY	BOX QTY
10BPB-25C	10 x 25	1	
10BPB-50C	10 x 50	1	
10BPB-100C	10 x 100	1	
15BPB-25C	15 x 25	1	8
15BPB-50C	15 x 50	1	6
15BPB-100C	15 x 100	1	4
15BPB-120C	15 x 120	1	4
15BPB-150C	15 x 150	1	3
15BPB-300C	15 x 300	1	
22BPB-25C	22 x 25	1	6
22BPB-50C	22 x 50	1	4

Suitable for central heating systems.



Easy to Handle



Ultra Flexible

SPEEDFIT PEX BARRIER PIPE



British Gas accepted for water pipe in vented and sealed central heating systems.

PART NO.	SIZE MM X M	PACK QTY	BOX QTY
10BPEX-25C	10 x 25	1	20
10BPEX-50C	10 x 50	1	10
10BPEX-100C	10 x 100	1	6
15BPEX-25C	15 x 25	1	8
15BPEX-50C	15 x 50	1	5
15BPEX-100C	15 x 100	1	5
15BPEX-120C	15 x 120	1	5
15BPEX-150C	15 x 150	1	4
22BPEX-25C	22 x 25	1	8
22BPEX-50C	22 x 50	1	5

Suitable for central heating systems.

SPEEDFIT PEX BARRIER PIPE



Straight lengths. 15 & 22mm in packs of 20. 28mm in packs of 10.

Minimum order for 6m lengths is 10 packs.

* By special order only.

PART NO.	SIZE MM X M	PACK QTY
15BPEX-20X2L	15 x 2	20
15BPEX-20X3L	15 x 3	20
15BPEX-20X6L	15 x 6	20
22BPEX-20X2L	22 x 2	20
22BPEX-20X3L	22 x 3	20
22BPEX-20X6L	22 x 6	20
28BPEX-10X3L	28 x 3	10
* 28BPEX-10X6L	28 x 6	10

Suitable for central heating systems.

PIPE IN PIPE



PART NO.	SIZE MM X M	PACK QTY
15PIP-50C-E	15 x 50	1
22PIP-50C-E	22 x 50	1

PIPE INSERT



To be used when connecting Speedfit Pipe to a compression fitting or fitting from another manufacturer.

PART NO.	SIZE MM	BAG QTY	SMALL BOX	LARGE BOX
TSM10N	10	50	1000	20,000
TSM15N	15	50	500	5000
TSM22N	22	25	250	2000
TSM28N	28	10	150	1000

Suitable for central heating systems.

SUPERSEAL PIPE INSERT



Only to be used with Speedfit Pipe and Speedfit fittings together, to give enhanced sealing.

See page 4 for details.

PART NO.	SIZE MM	BAG QTY	SMALL BOX	LARGE BOX
STS10	10	50	1000	12,500
STS15	15	50	500	5000
STS22	22	25	250	2000
STS28	28	10	150	100

Suitable for central heating systems.

RED AND BLUE PIPE AND PIPE ACCESSORIES

RED & BLUE SPEEDFIT PEX BARRIER PIPE



PART NO.	SIZE MM X M	PACK QTY
Red 15BPEX-20X6L-R	15 x 6	20
22BPEX-20X6L-R	22 x 6	20
Blue 15BPEX-20X6L-B	15 x 6	20
22BPEX-20X6L-B	22 x 6	20

Straight Lengths. The pipe has an inner barrier to stop the ingress of air.

Minimum order quantities: 15mm size, 20 packs of 20 lengths
22mm size, 10 packs of 20 lengths

CONDUIT PIPE



PART NO.	SIZE MM X M	PACK QTY
Black 15BLKCON-25C	15 x 25	1
15BLKCON-50C	15 x 50	1
22BLKCON-25C	22 x 25	1
22BLKCON-50C	22 x 50	1
Red 15REDCON-50C	15 x 50	1
22REDCON-50C	22 x 50	1
Blue 15BLUCON-50C	15 x 50	1
22BLUCON-50C	22 x 50	1

COLLET COVER

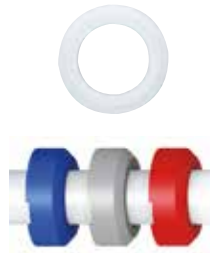

PART NO.	SIZE MM	BAG QTY	SMALL BOX	LARGE BOX
PKM1910W	10	100	500	
PKM1910R	10	100	500	
PKM1910B	10	100	500	
AM1915W	15	100	400	4000
PM1915R	15	100	400	
PM1915B	15	100	400	
AM1922W	22	50	200	2000
PM1922R	22	50	200	
PM1922B	22	50	200	

Suitable for central heating systems. Available in white, red or blue.

COLLET LOCKING CLIP



PART NO.	SIZE MM	BAG QTY	BOX QTY
CM1810S Grey	10	100	2000
CM1815S Grey	15	100	1000
CM1822S Grey	22	100	1000
CM1810W White	10	100	2000
CM1815W White	15	100	1000
CM1822W White	22	100	1000
CM1810R Red	10	100	2000
CM1815R Red	15	100	1000
CM1822R Red	22	100	1000
CM1810B Blue	10	100	2000
CM1815B Blue	15	100	1000
CM1822B Blue	22	100	1000

Suitable for central heating systems.

White and grey collet clips prevent accidental release of pipe from standard fittings. Red and blue clips provide colour coding of pipe, they should not be used to prevent accidental release of pipe.

PIPE CLIPS AND SPACERS



White

PART NO.	SIZE MM	PACK QTY	BOX QTY
PC15W	15	50	200
PC22W	22	50	100
PC28W	28	20	80
PCSW		50	400



Red

PC15R	15	50	200
PC22R	22	50	100
PC28R	28	20	80



Blue

PC15B	15	50	200
PC22B	22	50	100
PC28B	28	20	80

RELEASE AID



PART NO.	SIZE MM	BAG QTY	BOX QTY
10RA	10	10	500
15RA	15	10	500
22RA	22	10	400
28RA	28	10	300

Allows a firmer grip on the collet when removing pipe.

CONDUIT ELBOW



PART NO.	SIZE	BAG QTY	PACK QTY
CONELB	FITS 10, 15 & 22mm	10	70

COLD FORMING BEND



PART NO.	SIZE MM	PACK QTY	BOX QTY
10CFB	10	10	200
15CFB	15	10	30
22CFB	22	10	10

To help create a tighter bend than the minimum unsupported pipe.

BENDING SPRINGS



PART NO.	SIZE MM	PACK QTY	BOX QTY
JG-BS10	10		5
JG-BS15	15		5
JG-BS22	22		5

RADIATOR OUTLET PLATE



PART NO.	BAG QTY	BOX QTY
JG-ROP	1	25

Creates a neat outlet for 10mm supply pipes to a radiator. To be used with single gang 25mm steel KO boxes to BS 4662, fitted with rubber grommet.

NAIL CLIP



PART NO.	SIZE MM	PACK QTY	BOX QTY
NPC10	10	50	1000
NPC15	15	50	400
NPC22	22	50	250
NPC28	28	20	200

COLLETS



For PKM Fittings

PART NO.	SIZE MM	PACK QTY
PXC10	10	20
PXC15	15	20
SPF22	22	20
PXC28	28	20

For PEM Fittings

PXC10	10	20
PXC15	15	20
PXC22	22	20
PXC28	28	20

EPDM 'O' RING



PART NO.	SIZE MM	PACK QTY
10 EPR	10	20
15 EPR	15	20
22 EPR	22	20
28 EPR	28	20

THREAD WASHER



PART NO.	SIZE	PACK QTY
1/2 EPW	1/2	20
3/4 EPW	3/4	20

For use with Female Coupler/Tap Connector.

Part No.PSE3210W, PSE3201W, PSE3202W & PSE3203W

FOIL TAPE



PART NO.	SIZE MM X M	PACK QTY
JGTAPE	50 x 45	8

Metallic tape to meet NHBC requirements for plastic pipe to be detected inside walls.

PIPE CUTTER



PART NO.	PACK QTY	BOX QTY
JG-TS	1	30

For up to 22mm size pipe.

HEAVY DUTY PIPE CUTTER



PART NO.	PACK QTY	BOX QTY
JGHDC	1	20

For up to 28mm size pipe.

OTHER PLUMBING FITTINGS

CONVERSION CONNECTOR



PART NO.	SIZE	BAG QTY	BOX QTY
NC471	1/2id x 15mm	5	500
NC2324	3/4id x 22mm	5	30

Connects imperial to metric pipe.

Suitable for central heating systems.

SLIP CONNECTOR



PART NO.	SIZE MM	BAG QTY	BOX QTY
CM-SC-15S	15	10	60

Not suitable for central heating systems. Hot and Cold water only, 65°C maximum.

HOSE CONNECTOR



PART NO.	SIZE	BOX QTY
NC448	15mm x 1/2"	1000
NC473	22mm x 3/4"	400
NC737	22mm x 1/2"	500

Not suitable for central heating systems. Hot and cold water only, 65°C maximum.

UNEQUAL STRAIGHT CONNECTOR



PART NO.	SIZE MM X INCH	BAG QTY	BOX QTY
NC2511	15mm x 3/8"	10	150

Not suitable for central heating systems. Hot and cold water only, 65°C maximum.

BRAIDED FLEXI HOSES

Not suitable for central heating.

Hot and cold water only, 6 Bar @ 65°C



SPEEDFIT X UNION NUT

	PART No.	SIZE MM X BSP	BAG QTY	Box QTY	
150mm	FLX43P	15 x 1/2"	2	150	
	300mm	FLX34P	10 x 1/2"	2	150
		FLX35P	15 x 3/8"	2	150
		FLX15P	15 x 1/2"	2	100
		FLX16P	15 x 3/4"	2	100
		FLX22P	22 x 3/4"	2	100
500mm	FLX18P	15 x 1/2"	2	100	
	FLX20P	15 x 3/4"	2	80	
	FLX19P	22 x 3/4"	2	50	
	FLX23P Full Bore	22 x 3/4"	2	40	
1000mm	FLX40P	15 x 1/2"	1	20	
	FLX42	15 x 3/4"	5	25	
	FLX41P	22 x 3/4"	1	20	

SPEEDFIT X SPEEDFIT

	PART No.	SIZE MM X MM	BAG QTY	Box QTY
300mm	FLX33P	15 x 10	2	150
	FLX17P	15 x 15	2	100
	FLX26P	22 x 22	2	60
500mm	FLX21P	15 x 15	2	100
	FLX27P	22 x 22	2	60
1000mm	FLX47	15 x 15	5	25

SPEEDFIT X MALE

	PART No.	SIZE MM X BSP	BAG QTY	Box QTY
300mm	FLX49	15 x 3/8"	25	100

ELBOW PATTERN

	PART No.	SIZE MM X BSP	BAG QTY	Box QTY
300mm	FLX36P	15 x 1/2"	2	100

SPEEDFIT X PLAIN STEM

	PART No.	PIPE MM	STEM MM	BAG QTY	Box QTY
300mm	FLX53	15	15	25	100

SPEEDFIT X UNION NUT WITH SERVICE VALVE

	PART No.	SIZE MM X BSP	BAG QTY	Box QTY
300mm	Plastic Valves			
	FLX37P	15 x 1/2"	2	100
	FLX39P	22 x 3/4"	2	50
300mm	Plastic Valve with Handle			
	FLX37-H	15 x 1/2"	2	100
	FLX39-H	22 x 3/4"	2	50

SPEEDFIT X SPEEDFIT WITH SERVICE VALVE

	PART No.	SIZE MM X MM	BAG QTY	Box QTY
300mm	Brass Valve			
	FLX44P	15 x 15	2	80
500mm	FLX45P	15 x 15	2	60

FOR MONOBLOC MIXERS

	PART No.	SIZE MM X MALE	PACK QTY	Box QTY
300mm	FLX48	12 x M10	2	100
	FLX28	15 x M10	2	100
	FLX29	15 x M12	2	100

BRAIDED FLEXI HOSES

with Metal Connections

Not suitable for central heating.

Hot and cold water only, 10 Bar @ 85°C, 12.5 Bar @ 20°C

SPEEDFIT X UNION NUT WITH SERVICE VALVE

	PART No.	SIZE MM X BSP	BAG QTY	Box QTY
300mm	Brass Valve			
	FLX24P	15 x 1/2"	2	80
	FLX25P	22 x 3/4"	2	30
500mm	FLX31P	15 x 1/2"	2	50
	FLX38P	15 x 3/4"	2	50
	FLX32P	22 x 3/4"	2	30

1/4 Turn Valves. These valves have been designed to allow temporary servicing of downstream equipment and must only be used in the fully open or fully closed position.

Do Not use these Valves:

- In a partially open position to control flow.
- To provide a permanent termination.
- Without tubing assembled or plugged (or threaded connections sealed).
- As a tap or "faucet".

1/4 Turn Valves are indicated by this marker '●'

WHITE FLEXI HOSES



Not suitable for central heating.
Hot and cold water only, 6 Bar @ 65°C

SPEEDFIT X UNION NUT

	PART No.	SIZE MM X BSP	BAG QTY	Box QTY
300mm	WFLX15	15 x 1/2"	2	100
	WFLX16	15 x 3/4"	2	100
	WFLX22	22 x 3/4"	2	100
500mm	WFLX18	15 x 1/2"	2	100
	WFLX20	15 x 3/4"	2	100
	WFLX19	22 x 3/4"	2	50
1000mm	WFLX40	15 x 1/2"	1	20

SPEEDFIT X SPEEDFIT

	PART No.	SIZE MM X MM	BAG QTY	Box QTY
300mm	WFLX33	15 x 10	2	100
	WFLX17	15 x 15	2	100
	WFLX21	15 x 15	2	100

SPEEDFIT X PLAIN STEM

	PART No.	PIPE MM	STEM MM	BAG QTY	Box QTY
200mm	WFLX51	15	15	2	200

ELBOW PATTERN

	PART No.	SIZE MM X BSP	BAG QTY	Box QTY
300mm	WFLX36	15 x 1/2"	2	100

SPEEDFIT X UNION NUT WITH SERVICE VALVE

	PART No.	SIZE MM X BSP	BAG QTY	Box QTY
300mm	Plastic Valve with Handle			
	WFLX37-H	15 x 1/2"	2	100
	WFLX39-H	22 x 3/4"	2	50

FOR MONOBLOC MIXERS

	PART No.	SIZE MM X MALE	PACK QTY	Box QTY
300mm	WFLX28	15 x M10	2	100
	WFLX29	15 x M12	2	100

IDENTITY DISCS



For handles on service valves.

PART No.	PACK QTY	PACK QTY
FLX-RED	10	10
FLX-BLU	10	10

WHITE FLEXI HOSES With Plastic Wingnut

Hand tightening only, no spanner required
Not suitable for central heating.
Hot and cold water only, 6 Bar @ 65°C



SPEEDFIT X HAND TIGHTEN

	PART No.	SIZE MM X BSP	BAG QTY	Box QTY
300mm	PFLX15	15 x 1/2"	2	100
	PFLX16	15 x 3/4"	2	100
	PFLX22	22 x 3/4"	2	80
500mm	PFLX18	15 x 1/2"	2	100
	PFLX19	22 x 3/4"	2	50

SPEEDFIT X HAND TIGHTEN (WITH EXTRA HOSE FLEXIBILITY)



	PART No.	SIZE MM X BSP	BAG QTY	Box QTY
300mm	PFLX88	15 x 1/2"	1	100

SPEEDFIT X UNION NUT WITH SERVICE VALVE

	PART No.	SIZE MM X BSP	BAG QTY	Box QTY
Plastic Valves				
300mm	PFLX37	15 x 1/2"	2	100
500mm	PFLX78	15 x 1/2"	2	80
Plastic Valve with Handle				
300mm	PFLX37-H	15 x 1/2"	2	100

MERCHANDISING

WHITE FITTING DISPLAY STAND



NEW



PART No.	SIZE	QTY
JG-STAND/C	5.8' x 2.2'	1

Each stand will include :-
25 Trade Price Guides
Plus the following fittings

PRODUCT	SIZE MM	QTY
Straight	15	120
Straight	22	60
Elbow	15	100
Elbow	22	50
Tee	15	80
Tee	22	30
Stop End	15	80
Stop End	22	30
Female Connector	15 x 1/2	60
Female Connector	22 x 3/4	25
Tap Connector	15 x 1/2	30
Tap Connector	22 x 3/4	25
Service Valve	15	30
Reducer	22 x 15	30
Reducing Tee	22 x 22 x 15	15
Washing Machine Tap	15 x 3/4	20
Pipe Insert	15	500
Pipe Insert	22	250

PRE-PACKED FITTING DISPLAY STAND



PART No.	SIZE	QTY
JG-Stand/P	6' x 2'	1

The Stand will include:

PRODUCT	SIZE	QTY
Straight Connector	15	10
Straight Connector	22	10
Elbow	15	10
Elbow	22	10
Tee	15	10
Tee	22	10
Female Coupler/Tap Connector	15 x 1/2"	20
Female Coupler/Tap Connector	22 x 3/4"	20
Stop End	15	20
Stop End	22	20
Reducer	22 x 15	10
White Flexi Hose	15 x 1/2"	20
White Flexi Hose	22 x 3/4"	20
Washing machine Tap	15 x 3/4"	10
Service Valve	15	10
Pipe Insert	15	50
Pipe Insert	22	50
Pipe Cutter	-	1

Pipe not included.

FITTINGS DISPLAY STAND



NEW



PART No.	SIZE	QTY
JG-STAND/7	5.8' x 2.2'	1

This stand is supplied without product.

BUILDERS MERCHANT STAND



PART No.	SIZE	PACK QTY
JG-Stand/BM	6' x 2'	1

Each stand will include :-
Literature Dispenser, Header Board and the following fittings:

PRODUCT	SIZE	QTY
Equal Straight Connector	25	5
Equal Elbow Connector	25	5
Equal Tee Connector	25	5
Imperial Converter	25 x 3/4	5
Stop Cock	25 x 22	5
Stop Cock	25 x 15	5
PE-Copper Coupler	25 x 22	5
PE-Copper Coupler	25 x 15	5
End Stop	25	5
Wall Plate Elbow	25 x 1/2" BSP	5
Tube Support	25	50
300mm Flexi Hose FLX15P	15 x 1/2 BSP	10
300mm Flexi Hose FLX16P	15 x 3/4 BSP	10
300mm Flexi Hose FLX17P	15 x 15	10
300mm Flexi Hose FLX22P	22 x 3/4" BSP	10

BLUE SPEEDFIT FITTINGS FOR MDPE STAND



PART No.	SIZE	PACK QTY
JG-Stand/UG2	6' x 2'	1

Each stand will include :-
Header Board
Trade Price Guides

PRODUCT	SIZE	QTY
Equal Straight Connector	20	6
Equal Straight Connector	25	6
Reducing Straight Connector	25 x 20	6
PE-Copper Coupler	20 x 15	6
PE-Copper Coupler	25 x 15	6
PE-Copper Coupler	25 x 22	6
PE-Copper Coupler	32 x 22	6
Equal Elbow	20	6
Equal Elbow	25	6
Equal Tee	20	6
Equal Tee	25	6
Stop End	20	6
Stop End	25	6
Back Plate Elbow	20 x 1/2" BSP	6
Back Plate Elbow	25 x 1/2" BSP	6
Stop Tap	25 x 15	4
Stop Tap	25 x 22	4
Stop Tap	25 x 25	4
Pipe Insert	20	60
Pipe Insert	25	60
Imperial Converter	20 x 1/2"	6
Imperial Converter	25 x 3/4"	6

PRE-PACKED PRODUCTS

Products packed in a bag with instructions



FOR MERCHANDISING SUPPORT
SEE PAGE 19

EQUAL STRAIGHT CONNECTOR



PART NO.	SIZE MM	BAG QTY	BOX QTY
PEM0410WP	10	1	400
PEM0415WP	15	1	250
PEM0422WP	22	1	150
PEM0428WP	28	1	75

Suitable for central heating systems.

REDUCING STRAIGHT COUPLER



PART NO.	SIZE MM	BAG QTY	BOX QTY
PEM201510WP	15 x 10	1	250
PEM202215WP	22 x 15	1	200

Suitable for central heating systems.

EQUAL ELBOW



PART NO.	SIZE MM	BAG QTY	BOX QTY
PEM0310WP	10	1	400
PEM0315WP	15	1	250
PEM0322WP	22	1	150
PEM0328WP	28	1	75

Suitable for central heating systems.

REDUCING ELBOW



PART NO.	SIZE MM	BAG QTY	BOX QTY
PEM211510WP	15 x 10	1	250
PEM212215WP	22 x 15	1	150

Suitable for central heating systems.

STEM ELBOW



Provides a swivel type connection.

PART NO.	PIPE	STEM	BAG QTY	BOX QTY
PEM221010WP	10	10	1	400
PEM221015WP	10	15	1	300
PEM221515WP	15	15	1	250
PEM222222WP	22	22	1	200

Suitable for central heating systems.

Please note a Collet Cover cannot be used on a Speedfit end assembled with the stem of a 22mm Stem Elbow.

135° STEM ELBOW



PART NO.	SIZE MM	BAG QTY	BOX QTY
PEM571515WP	15	1	250
PEM572222WP	22	1	150

Suitable for central heating systems.

EQUAL TEE



PART NO.	SIZE EACH	BAG QTY	BOX QTY
PEM0210WP	10	1	300
PEM0215WP	15	1	200
PEM0222WP	22	1	100
PEM0228WP	28	1	50

Suitable for central heating systems.

REDUCING TEE



Sizes listed as follows.



PART NO.	SIZE MM	BAG QTY	BOX QTY
PEM3015BWP	15x10x10	1	250
PEM3015AWP	15x15x10	1	200
PEM3022CWP	15x15x22	1	100
PEM3022BWP	22x15x15	1	100
PEM3022DWP	22x15x22	1	100
PEM302210AWP	22x22x10	1	150
PEM3022AWP	22x22x15	1	100
PEM3028BWP	28x22x22	1	75
PEM302815AWP	28x28x15	1	50
PEM3028AWP	28x28x22	1	50
PEM3028DWP	28x22x28	1	50

Suitable for central heating systems.

STOP END



PART NO.	SIZE MM	BAG QTY	BOX QTY
PSE4610WP	10	1	500
PSE4615WP	15	2	600
PSE4622WP	22	2	400
PSE4628WP	28	1	200

Suitable for central heating systems.

STEM TEE



Sizes listed as follows.

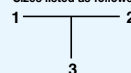

PART NO.	SIZE MM	BAG QTY	BOX QTY
PEM532210WP	22x22x10	1	150
PEM532215WP	22x22x15	1	150

Suitable for central heating systems.

FEMALE COUPLER - TAP CONNECTOR



Requires hand tightening only.

PART No.	SIZE MM X BSP	BAG QTY	Box QTY
PSE3210WP	10 x 1/2"	2	600
PSE3201WP	15 x 1/2"	2	400
PSE3203WP	15 x 3/4"	2	400
PSE3202WP	22 x 3/4"	2	200

Suitable for central heating systems.
Note: Plastic threads are not as strong as metal threads.
For torque figures see Technical Checklist.

STRAIGHT TAP CONNECTOR



PART No.	SIZE MM X BSP	BAG QTY	Box QTY
PEMSTC1014P	10 x 1/2"	1	300
PEMSTC1514P	15 x 1/2"	1	200
PEMSTC1516P	15 x 3/4"	1	200
PEMSTC2216P	22 x 3/4"	1	200

Suitable for central heating systems.
With brass swivel nut and sealing washer.
For torque figures see Technical Checklist.

BENT TAP CONNECTOR



PART No.	SIZE MM X BSP	BAG QTY	Box QTY
PEMBTC1014P	10 x 1/2"	1	300
PEMBTC1514P	15 x 1/2"	1	200

Suitable for central heating systems.
With brass swivel nut and sealing washer.
For torque figures see Technical Checklist.

PIPE REPAIR KIT



PART No.	SIZE MM	BAG QTY	Box QTY
15RKP	15	1	80
22RKP	22	1	50

Suitable for central heating systems.

Provides a simple way of repair on a rigid pipe run.

Remove a damaged section of pipe and replace with a repair kit

SLIP TEE CONNECTOR



PART No.	SIZE MM	BAG QTY	Box QTY
15TKP	15	1	80
22TKP	22	1	40

Suitable for central heating systems.

Provides a simple way to break into an existing pipe run

REDUCER



PART No.	SIZE MM	BAG QTY	Box QTY
PEM061510WP	15 x 10	1	400
PEM062215WP	22 x 15	1	250
PEM062815WP	28 x 15	1	200
PEM062822WP	28 x 22	1	150

Suitable for central heating systems.

TANK CONNECTOR



Requires hand tightening only.

Maximum wall thickness of tank = 4mm.

PART No.	SIZE MM	BAG QTY	Box QTY
CM0715SP	15	1	200
CM0722SP	22	1	100

Suitable for cold water tanks only.

4 WAY MANIFOLD



PART No.	SIZE MM	BAG QTY	Box QTY
SFM512210EP	22 x 10	1	150

Suitable for central heating systems.

4 PORT RAIL MANIFOLD



PART No.	SIZE MM	BAG QTY	Box QTY
SFM522210EP	22 x 10	1	50
SFM522215EP	22 x 15	1	40

Suitable for central heating systems.

BRASS MALE COUPLER



PART No.	SIZE MM X BSP	BAG QTY	Box QTY
15MC(1/2)P	15mm x 1/2"	1	50
22MC(3/4)P	22mm x 3/4"	1	50

Suitable for central heating systems.

Manufactured in DZR Brass.

BRASS BACK PLATE ELBOW



PART No.	SIZE MM X BSP	BAG QTY	Box QTY
15WBP	15 x 1/2"	1	25

Suitable for central heating systems.

Manufactured in DZR Brass.

BRASS MALE CYLINDER ADAPTOR

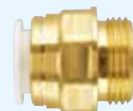

PART No.	SIZE MM X BSP	BAG QTY	Box QTY
22CMAP	22 x 1"	1	40

Suitable for central heating systems.

Manufactured in DZR Brass.

BRASS FEMALE CYLINDER ADAPTOR

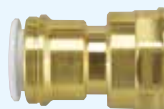

PART No.	SIZE MM X BSP	BAG QTY	Box QTY
22CFAP	22 x 1"	1	30

Suitable for central heating systems.

Manufactured in DZR Brass.

PRE-PACKED PRODUCTS CONTINUED

Products packed in a bag with instructions



FOR MERCHANDISING SUPPORT
SEE PAGE 19

PRE-PACKED VALVES

PLASTIC SERVICE VALVE



PART No.	SIZE MM	BAG QTY	Box QTY
15SVP	15	1	200
22SVP	22	1	150

Not suitable for central heating systems.
Hot and Cold water only, 65°C maximum.

PLASTIC SERVICE VALVE WITH TAP CONNECTOR



PART No.	SIZE MM X BSP	BAG QTY	Box QTY
Grey 15SVSTCP	15 x 1/2"	1	200
White 15SVSTC-WP	15 x 1/2"	1	200

Not suitable for central heating systems.
Hot and Cold water only, 65°C maximum.

PLASTIC ANGLE SERVICE VALVE WITH TAP CONNECTOR



PART No.	SIZE MM X BSP	BAG QTY	Box QTY
Grey 15SVBTC	15 x 1/2"	1	200
White 15SVBTC-WP	15 x 1/2"	1	200

Not suitable for central heating systems.
Hot and Cold water only, 65°C maximum.

STOP VALVE



PART No.	SIZE MM	BAG QTY	Box QTY
15STVP	15	1	100
22STVP	22	1	50

Not suitable for central heating systems.
Hot and Cold water only, 65°C maximum.

BRASS STOP VALVE



PART No.	SIZE MM	BAG QTY	Box QTY
15BSCP	15	1	10

Only suitable for central heating systems.
Manufactured in DZR Brass.

WASHING MACHINE TAP



PART No.	SIZE MM X BSP	BAG QTY	Box QTY
15APT	15 x 3/4"	1	200

Not suitable for central heating systems.
Hot and Cold water only, 65°C maximum.
For maximum torque figures on plastic thread,
please see Technical Checklist.

APPLIANCE TEE



PART No.	SIZE MM X BSP	BAG QTY	Box QTY
15APT2P	15 x 3/4"	1	150

Not suitable for central heating systems.
Hot and Cold water only, 65°C maximum.
For maximum torque figures on plastic thread,
please see Technical Checklist.

EMERGENCY SHUT OFF TAP



PART No.	SIZE MM	BAG QTY	Box QTY
15ESOTP	15	1	200

Not suitable for central heating systems.
Hot and Cold water only, 65°C maximum.

BRASS CHROME PLATED SERVICE VALVE



PART No.	SIZE MM	BAG QTY	Box QTY
10HSVP	10	1	50
15HSVP	15	1	50
22HSVP	22	1	20

Suitable for central heating systems.

BRASS CHROME PLATED SERVICE VALVE

WITH TAP CONNECTOR ●



PART No.	SIZE MM X BSP	BAG QTY	Box QTY
15PTSVP	15 x 1/2"	1	50
22PTSVP	22 x 3/4"	1	20

Suitable for central heating systems.

BRASS CHROME PLATED BALL VALVE ●



PART No.	SIZE MM	BAG QTY	Box QTY
15BVP	15	1	40
22BVP	22	1	20

Suitable for central heating systems.
Each valve has a red and a blue indice.

BRASS DRAIN COCK



PART No.	SIZE MM	BAG QTY	Box QTY
15BDP	15	1	50

Suitable for central heating systems.
Manufactured in DZR Brass.
Speedfit Drain Cocks cannot be used where collet covers are fitted.
They can be used with a standard fitting fitted with a collet clip.

DOUBLE CHECK VALVE



PART No.	SIZE MM	BAG QTY	Box QTY
15DCVP	15	1	200

Not suitable for central heating systems.
Hot and Cold water only, 65°C maximum.

1/4 Turn Valves. These valves have been designed to allow temporary servicing of downstream equipment and must only be used in the fully open or fully closed position.

Do Not use these Valves:

- In a partially open position to control flow.
- To provide a permanent termination.
- Without tubing assembled or plugged (or threaded connections sealed).
- As a tap or "faucet".

1/4 Turn Valves are indicated by this marker '●'

PRE-PACKED PIPE & PIPE ACCESSORIES

SPEEDFIT PEX BARRIER PIPE



PART No.	SIZE MM X M	PACK QTY	Box QTY
10BPEX-25C	10 x 25	1	20
15BPEX-25C	15 x 25	1	8
15BPEX-50C	15 x 50	1	5
22BPEX-25C	22 x 25	1	8
22BPEX-50C	22 x 50	1	5

British Gas accepted for water pipe in vented and sealed central heating systems.

Suitable for central heating systems.

SPEEDFIT PEX BARRIER PIPE



PART No.	SIZE MM X M	PACK QTY
15BPEX-20X2L	15 x 2	20
15BPEX-20X3L	15 x 3	20
22BPEX-20X2L	22 x 2	20
22BPEX-20X3L	22 x 3	20
28BPEX-10X3L	28 x 3	10

Straight lengths.
15 & 22mm in packs of 20.
28mm in packs of 10.

Suitable for central heating systems.

PIPE INSERT



PART No.	SIZE MM	BAG QTY	Box QTY
TSM10NP	10	10	5000
TSM15NP	15	10	3000
TSM22NP	22	5	1000
TSM28NP	28	5	500

To be used when connecting Speedfit Pipe to a compression fitting or fitting from another manufacturer.

Suitable for central heating systems.

SUPERSEAL PIPE INSERT



PART No.	SIZE MM	BAG QTY	Box QTY
STS10P	10	10	5000
STS15P	15	10	3000
STS22P	22	5	1000

Only to be used with Speedfit Pipe and Speedfit fittings together, to give enhanced sealing.

Suitable for central heating systems.

See page 4 for details.

NAIL CLIP



PART No.	SIZE MM	BAG QTY	Box QTY
NPC10P	10	20	5000
NPC15P	15	20	2000
NPC22P	22	10	1000

PIPE CUTTER



PART No.	PACK QTY	Box QTY
JG-TS	1	30

For up to 22mm size pipe.

JG Speedfit® Blue

FITTINGS FOR COLD WATER SERVICES

ABOVE AND BELOW GROUND



This range of fittings for MDPE Pipe has an improved collet with stainless steel teeth to provide extra grip on the pipe and has WRAS Approval.



APPLICATIONS

Speedfit underground fittings for MRS PE80 metric size polyethylene cold water service pipe have been designed for connection of:

1. **Blue MDPE pipes to BS 6752** - used for underground service pipes for potable water.
2. **Black MDPE pipes to BS 6730** - used for conveyance of potable water above ground or for industrial services above or below ground.
3. **Blue pipe to BS EN 12201-2, 20mm PN16, 25mm and 32mm PN12.5.**

Making the connection could not be easier. All you need is the pipe, the fitting and a pair of hands. The range is designed to provide a long service life and includes adaptors for screwed pipe, copper and imperial sized LDPE.



INSTALLATION BENEFITS

- Easy to use in confined spaces, no tools required.
- Fast installation with resulting cost savings.
- Lightweight and slimline.
- Ready for immediate installation, no dismantling.
- No adjustments required after fitting.
- Adaptors for screwed pipe, copper and imperial LDPE.

PERFORMANCE BENEFITS

- Maintenance free.
- Durable with high resistance to impact.
- Patented collet ensures high resistance to pull out.
- Lead free and non toxic.
- Will not support biological growth.
- A reliable and trouble free leakproof connection.

The Technical Checklist for Cold Water Services Fittings is on page 39.

MAKING A GOOD CONNECTION



Cut pipe square using pipe cutters remove burrs and sharp edges.

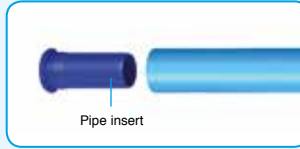

Always use a Speedfit Pipe Insert, which must be fully inserted.

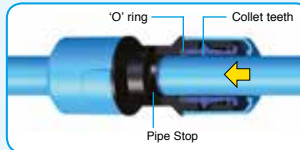

Push the pipe into the fitting, up to the pipe stop. The Stainless Steel teeth grip the pipe, the "O" ring provides a permanent leakproof seal.



Pull to check the system is secure then test the system to ensure it is water tight.

TO DISCONNECT



Ensure the system is depressurised. Remove the Collet Cover by sliding it along the pipe. Squeezing the raised portions will aid removal.



Push the Collet square against the fitting. With the Collet held in this position, the pipe can be withdrawn.



Sales support material for this range includes Counter Mats and Display Stands.

FOR DISPLAY STAND SUPPORT SEE PAGE 20.

EQUAL STRAIGHT CONNECTOR



PART No.	SIZE MM	BAG QTY	BOX QTY
UG401B	20	1	100
UG402B	25	1	60
UG403B	32	1	40

Cold water only

REDUCING STRAIGHT CONNECTOR



PART No.	SIZE MM	BAG QTY	BOX QTY
UG501B	25 x 20	1	80
UG502B	32 x 25	1	50

Cold water only

PE-COPPER COUPLER



PART No.	SIZE MM	BAG QTY	BOX QTY
UG601B	20 x 15	1	150
UG603B	25 x 15	1	100
UG602B	25 x 22	1	80
UG604B	32 x 28	1	60

Cold water only

Used to connect PE Pipe to copper or Speedfit Plumbing Pipe. Must not be buried directly into ground, soil, concrete or other substrates.

MALE ADAPTOR



PART No.	SIZE MM	BAG QTY	BOX QTY
UG101B	20 x 1/2" BSP	1	150
UG102B	25 x 3/4" BSP	1	100
UG103B	32 x 1" BSPT	1	60
UG104B	32 x 1.1/2" BSPT	1	80

Cold water only

FEMALE ADAPTOR



PART No.	SIZE MM X BSP	BAG QTY	BOX QTY
UG4501B	20 x 1/2"	1	100
UG4502B	25 x 3/4"	1	100

Cold water only

EQUAL ELBOW



PART No.	SIZE MM	BAG QTY	BOX QTY
UG301B	20	1	100
UG302B	25	1	50
UG303B	32	1	30

Cold water only

BACK PLATE ELBOW



PART No.	SIZE MM X BSP	BAG QTY	BOX QTY
UGPWB2014	20 x 1/2"	1	100
UGPWB2514	25 x 1/2"	1	70
UGPWB2516	25 x 3/4"	1	70

Cold water only

WING BACK ELBOW



PART No.	SIZE MM X BSPT	BAG QTY	BOX QTY
UGPWB1514	15 x 1/2"	1	150

Cold water only

STEM ELBOW



PART No.	PIPE OD MM	STEM OD MM	BAG QTY	BOX QTY
UG222025B	20	25	1	100
UG222525B	25	25	1	80
UG223232B	32	32	1	50

Cold water only

Stem cannot be disconnected from mating connector with collet cover fitted.

EQUAL TEE



PART No.	SIZE MM	BAG QTY	BOX QTY
UG201B	20	1	50
UG202B	25	1	40
UG203B	32	1	15

Cold water only

REDUCING TEE



PART No.	SIZE ENDS	SIZE BRANCH	BAG QTY	BOX QTY
UG232AB	32	25	1	15

Cold water only

REDUCER



PART No.	SIZE MM	BAG QTY	BOX QTY
UG063228B	32 x 28	1	75

Cold water only

STOP END



PART No.	SIZE MM	BAG QTY	BOX QTY
UG4620B	20	1	150
UG4625B	25	1	100

Cold water only

STOP TAP - MDPE x MDPE



PART No.	SIZE MM	BAG QTY	BOX QTY
UGSTV2020	20	1	40
UGSTV2525	25	1	30
UGSTV3232	32	1	15

Cold water only

The two Stoptaps for 15 or 22mm copper or PEX Pipe must not be buried directly into ground, soil, concrete or other substrates.

STOP TAP - MDPE x COPPER OR PEX



PART No.	SIZE MM	BAG QTY	BOX QTY
UGSTV2515	25 x 15	1	40
UGSTV2522	25 x 22	1	40

Cold water only

The two Stop Taps for 15 or 22mm copper or PEX Pipe must not be buried directly into ground, soil, concrete or other substrates.

PLUGS



PART No.	SIZE MM	BAG BOX	BOX QTY
UG801E	20	1	50
UG802E	25	1	40
UG803E	32	1	30

Cold water only

PIPE INSERT



PART No.	SIZE MM	BAG QTY	BOX QTY
UTS147-DB	20	10	200
UTS197-DB	25	10	150
UTS251-DB	32	2	300

IMPERIAL CONVERTER



PART No.	STEM MM	IMPERIAL PIPE SIZE	BAG QTY	BOX QTY
UGICO1	20	1/2"	1	100
UGICO2	25	3/4"	1	80

Supplied with inch size Pipe Insert

To convert metric size fitting for use with imperial size LDPE to BS1972 Class C. Stem cannot be disconnected from mating connector with collet cover fitted.

SYSTEM CONNECTIONS

CONNECTION TO COMPRESSION FITTING

Many but not all compression fittings are suitable for use with plastic fittings and pipe. Users should therefore check for compatibility. Compression fittings with short tube stop depth or brass olives should not be used with plastic fittings or pipe.

When using compression fittings with Speedfit pipe, a Standard Pipe Insert (prefix TSM) must be used to withstand the compressive pressure of the olive. The olive must be located within the length of the pipe insert and the pipe fully inserted into the fitting. The connection should not need more than 2 full turns after the olive has gripped the pipe. JG Speedfit recommend the use of soft copper olives.

Ensure nut and olive are in place before inserting pipe insert.

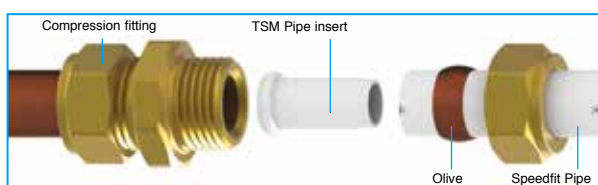

CONNECTION TO IMPERIAL PIPE AND FITTINGS

The Speedfit Range includes couplers to connect Speedfit Pipe to 1/2" to 1" BSP and BSPT. See page 13.

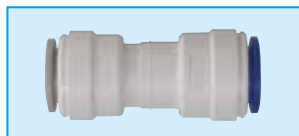

Fittings to connect imperial pipe to metric are shown on page 16.

CONNECTION TO CHROME-PLATED COPPER PIPE



Speedfit fittings can be connected onto chromium plated copper pipe if the chromium plating is completely removed to the full depth of the fitting. To ensure maximum grip, the fitting of a collet clip is recommended.

It is not possible to connect Speedfit fittings to Stainless Steel Pipe.

CONNECTION TO MAINS SUPPLY

In modern properties, water enters a building usually in blue MDPE (medium density polyethylene) pipe. In order to comply with Water Regulation Schedule 2.10, the internal plumbing system should be connected via a Speedfit Stop Tap from our Cold Water Services Range, Part No.'s UGSTV2515, 25mm x 15mm or UGSTV2522, 25mm x 22mm.

Connection of Speedfit Pipe to supply pipe of other materials should be via a stop tap with a 15mm or 22mm compression outlet.

CONNECTION TO BOILERS

Speedfit pipe should never be connected directly to a boiler.

Although most modern boilers have a high limit thermostat, residual heat can be conducted by the heat exchanger. Therefore, Speedfit recommend a minimum of 1 metre from the boiler casing should be run in copper pipe unless otherwise stated in the boiler manufacturer's installation literature.

A gravity primary circuit operating on an uncontrolled cooking range or solid fuel boiler should be run entirely in copper and the heating circuit run in copper for the first metre.

Refer to BS 5955: Part 8 for further clarification.

All appliances should have safety devices to make sure they cannot operate above the working temperature and pressure range set out in our Technical Checklist on page 38. If safety devices are not incorporated within the appliance then external controls will be needed.

Water meters (and other devices) can contain check valves that prevent the expansion of heated water back down the main supply from a combi boiler. If plastic pipe is to be used, a suitable expansion vessel must be fitted. This is especially important to consider if a water meter is fitted retrospectively. Speedfit do not recommend the use of plastic pipe on the main supply between a water meter and a combi boiler if an expansion vessel is not fitted.

Speedfit Products should not be fitted to a sealed system oil boiler, a back fired boiler or other uncontrolled heat source.

Please also see **Drop-Pipe Systems** on page 28 and **System Commissioning and Flushing** on page 32.

CONTINUOUSLY OPERATED RE-CIRCULATING SYSTEMS (SECONDARY HOT WATER CIRCULATION/RING MAIN INSTALLATIONS):

A continuously operated re-circulating system is a water-replenished circulating system which is maintained at a constant high temperature to provide a constant source of hot water. Continuously operated re-circulating systems are used to distribute constant hot water to draw off points that may be distant from the source or hot water storage vessel.

Continuously operated re-circulating systems are very different from conventional hot water supply and central heating systems found in domestic properties, for which our products have been tested to, under either BS7291:2010 Class S or WRAS approval standards, and for this reason Speedfit products must not be used on any continuously operated re-circulating systems as they are not approved under the current version of these standards.

UNVENTED PRESSURISED CYLINDERS

Unvented Pressurised Cylinders can be installed using Speedfit pipe and fittings. However if the safety parameters of the cylinder exceed those of the pipe and fittings it is possible to fit a pressure reduction valve on the out going hot supply pipe. This will not interfere with any other cylinder safety

devices demanded by regulations as they are all fitted in the incoming side of the cylinder.

Run a short length of copper pipe from the cylinder connection (about 150mm - 300mm) then fit a suitable pressure reduction valve. This will protect the pipe and fittings from excessive pressure in the event of boiler / cylinder malfunction. The factory fitted temperature / pressure relief valve on the cylinder will discharge below 100°C therefore protecting the pipe from excessive temperature.

CONNECTION TO CYLINDERS & WATER HEATERS

Speedfit can be used on sealed and open vented heating systems, where boilers are either heating a hot water storage cylinder or instantaneous hot water such as a combination boiler. The temperature and pressure limits of the system must not exceed the maximum values stated under the heading 'Working Temperatures and Pressures'.

When using a traditional copper vented cylinder Speedfit Pipe and Fittings can be installed with direct connections to the cylinder. Unvented pressurised cylinders can be installed using Speedfit Pipe and Fittings. However, insertion depths on compression joints that form part of the cylinder must be checked prior to installation and the use of standard pipe inserts (Prefix TSM) is recommended.

In accordance with current U.K. Building Regulations (Part G), discharge pipes from temperature and/or pressure relief valves must be run in metal pipework.

Speedfit connections to combined Cylinder/Boiler units and Thermal Storage Units must be made outside the casing unless otherwise stated in manufacturers installation literature.

DROP-PIPE SYSTEMS

Care should be taken when designing and installing a central heating system where radiators are supplied by pipe work which drops from an upper floor.

With this kind of system it is possible to trap air in the upper floor pipe work. When the boiler is fired the increase in pressure within the pipe caused by expanding air could cause the pipe to burst.

It is therefore essential that the system be designed so that any air can be removed from the system either automatically or manually by installing automatic or manual air vents at the highest points of the system.

CONNECTION TO PUMPS AND VALVES

Speedfit Pipe should be connected to circulating pumps and motorised valves in accordance with the section in this book headed, "Connecting Plastic Pipe To Compression Fittings". If Speedfit Pipe is not mounted on a supporting structure, the pipe must be clipped close to the component's connections to ensure adequate support and to assist in the reduction of vibration.

For heavier equipment, ensure that appropriate metal brackets provide full and independent support of the components and that it does not rely solely on the pipework for support.

CONNECTION TO COPPER PIPE

The minimum distance to make a solder connection on copper pipe inserted into a Speedfit Fitting is 450mm (18 inches). Ensure that any residual flux solder is not allowed to come in contact with the fitting. That same measurement is the safe distance to use a freezer kit to Speedfit Pipe.

CONNECTING TO COLD WATER STORAGE TANK

To install the Speedfit Tank Connector, unscrew the nut and push the body of the fitting through the tank hole with the washer on the inside of the tank. Hand tighten the nut onto the body. Push the pipe into the connector.

Note: Hand tightening the nut onto the body is all that is required. Further mechanical tightening will damage the fitting.

Maximum wall thickness of tank 4mm



PREVENTING BACK FLOW

The Speedfit Range includes a Double Check Valve (Part No 15DCV) to enable installers to comply with Water Regulation Schedule 2.15, thus preventing contamination of water arising from back siphonage, backflow or cross connection. Suitable for use with fluid categories 1, 2 and 3 only.



RADIATOR CONNECTIONS

The most common way of running pipework to a radiator is to run both flow and return pipes central to the radiator position.

The pipes exit a single gang box (fitted with rubber grommets) located at the mid height of the finished radiator position. This also provides a fixed point for other trades to work to and reduces the risk of damage to the pipework.

Once the plasterboard is installed the pipes are passed through the Speedfit Radiator Outlet Plate to exit plasterboard without the need of unsightly holes.



Metal reducing sets which convert radiator valves from 15mm to 10mm are not suitable for use with Speedfit Fittings or Pipe as they can cause damage to the plastic.

ELECTRICAL CONTINUITY

The plumbing or heating system installer should have these aspects checked to ensure compliance with current IEE Regulations. If in doubt please contact the Speedfit Technical Advisory Service or consult your local Electricity Authority.

IEE Guidance Note 7 provides useful guidance on the design of electrical installations where there is increased risk of electric shock. It recognises that the requirement for supplementary bonding may be relaxed where metal taps and plastic pipes supply other bathroom fittings.

Similarly a metal bath or radiator not connected to an extraneous-conductive-part is not required to be connected to the local supplementary conductors.

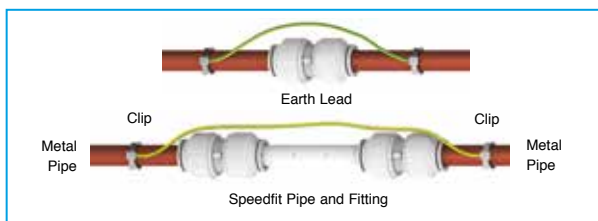

SUPPLEMENTARY BONDING TO BATHROOMS

Pipe Material			Supplementary Bond Required Between	Comments
Cold Water	Hot Water	Central Heating		
P	P	P	Earth terminals of protective conductors of class I and of class II equipment and accessible exposed conductive parts of the building structure.	Bonding of metal taps metal radiators or metal baths is not required unless the bath is connected to the metallic building structure.
P	M	M	Hot water pipe, central heating pipes, earth terminals of protective conductors of class I and class II equipment and accessible exposed conductive parts of the building structure.	A bond is not required to the taps either hot nor cold, or to metal baths unless connected to the metallic building structure.
P	P	M	Central heating pipes, the earth terminals of protective conductors of class I and class II equipment and access to exposed conductive parts of the building structure.	Bonding of metal water taps is not required, nor metal baths unless connected to the metallic building structure.
M	M	M	All metal pipes, earth terminals of protective conductors class I and class II equipment, and accessible exposed conductive parts of the building structure.	Metal pipes themselves can be used as bonding conductors if joints are metal to metal and electrically continuous.
M	M	P	All metal pipes, earth terminals of protective conductors of class I and class II equipment, and accessible exposed conductive parts of the building structure.	Metal central heating radiator does not require bonding.

P = Plastic **M** = Metal **NB: All Waste Pipes are plastic.**

- Supplementary bonding is carried out to the earth terminal protective conductors of class I and class II equipment within the bathroom. A supplementary bond is not run back to the main earth.
- Metal window frames are not required to be supplementary bonded unless they are electrically connected to the metallic structure of the bonding.
- Metal baths supplied by metal pipes do not require supplementary bonding if all the pipes are bonded and there is no other connection of the bath to earth.
- All bonding connections must be accessible and labelled "Safety Electrical Connection - Do Not Remove".

CONNECTING TO OTHER PLUMBING FIXTURES

As shown in the Product Range List, the Speedfit Range of fittings includes valves, taps, adaptors and connectors for the plumbing of all typical domestic appliances and fittings.

DISCHARGE PIPES

Speedfit Pipe should not be used to provide the discharge from unvented cylinders, unvented water heaters and sealed systems via the temperature relief and pressure relief valves.

WATER HEATERS

Speedfit recommend that mains supply pipework to unvented water heaters (up to 15ltr capacity), be run in metal pipes.

Adequate provision must also be made regarding thermal expansion of water from a water heater. The use of an expansion relief valve and / or an expansion vessel must be used where water expansion is not possible back into the mains supply.

Ensure water temperatures do not exceed those recommended for Speedfit.

INSTALLING PIPEWORK

SPEEDFIT BARRIER PIPE

Speedfit Barrier Pipe is manufactured to BS 7291 Parts 1, 2 and 3 Class S and is Kitemarked.



It is made up of 5 layers, the centre of which is a blue coloured oxygen barrier which prevents the ingress of air into the system, thereby reducing the effect of corrosion on metal components. Because of its low thermal conductivity

when carrying hot water, Speedfit Pipe is cooler and therefore safer to touch. Relatively low heat loss through radiation means that a system retains its heat longer and delivers hot water more quickly and with less wastage than a metal system.



The pipe is available in coils and straight lengths. See page 13. Pipe markings are spaced to aid the making of a good connection when using a Superseal Pipe Insert.

PIPEWORK SIZING

For general guidance on pipework sizing, please refer to BS EN 806 and complimentary guidance document BS 8558, or the Institute of Plumbing Engineering Services Design Guide. Speedfit Fittings are suitable for pipes within ± 0.1 mm of nominal size. They can be used with copper pipe to BS EN 1057 or Speedfit Plastic Pipe.

The Product Range List shows the fittings available for reducing pipe diameters within the system.

Speedfit Pipe is available in straight lengths and coils.

PIPE BENDING

Gentle bends can be made with pipe clips on either side of the curve, positioned to maintain the bend radius.



Tighter bends can be achieved by using the cold forming bends shown on page 16.



Internal Bending Springs are available in 10mm to 22mm sizes. See page 16.

It is also possible to bend Speedfit Pipe using a standard pipe bender. The pipe should not be heated with a blowlamp or hot air gun.

Minimum bend radii for Speedfit pipe (BPEX and BPB) are as follows:

Speedfit Min Radius	Pipe Diameter			
	10mm	15mm	22mm	28mm
with Cold Forming Bends	30mm	75mm	110mm	-
with Clips	100mm	175mm	225mm	300mm

BPB Min Radius	Pipe Diameter			
	10mm	15mm	22mm	28mm
with Cold Forming Bends	30mm	75mm	110mm	-
with Clips	80mm	120mm	176mm	-

For bends of radii smaller than those shown, standard elbow fittings are recommended.

PIPE SUPPORT AND CLIPPING

There are two types of pipe clip in the Speedfit Range.



Firstly, a nail clip is used for fixing to timber when running concealed pipe work i.e. underfloor or in a roof space. This clip takes less time to fit and is compact which allows pipework to be fixed close together when space is at a premium.



The second type uses a screw and therefore takes a little longer to fix. When pipes are required to cross over, it is possible to add a spacer to the clip. This will give room between the pipe and the wall to allow the pipes to cross over. If pipework needs to be insulated, using the spacer will give room for the lagging to be applied.

Pipe clips should not be fitted any closer than 60mm from the end of the fitting to allow for expansion. Pipes should always be adequately supported to prevent undue stress or side load on the fittings.

RECOMMENDED CLIP SPACING

For surface mounted pipes.

Pipe Diameter	Clip Spacing	
	Horizontal Run	Vertical Run
10 - 15mm	300mm	500mm
22mm	500mm	800mm
28mm	800mm	1,000mm

PIPE SIZING

For general guidance on pipework sizing, please refer to BS EN 806 and complimentary guidance form BS 8558, and BS EN 12828 or the Institute of Plumbing Engineering Services Design Guide. Speedfit Fittings are suitable for connection to pipe sizes within ± 0.1 mm of nominal size.

The maximum heat carrying capacity and flow of Speedfit Pipe, based on 1.2m/s velocity and an 11°C temperature drop is shown in the table below.

Pipe size	Max Capacity KW	Max Flow litres/sec	Headloss m/m pipe
10mm	1.948	0.042	0.283
15mm	5.941	0.129	0.139
22mm	13.604	0.295	0.084
28mm	21.991	0.478	0.062

PIPEWORK INSULATION

The insulation requirements for Speedfit Pipe are the same as those for copper and should comply with BS EN 806 and complimentary guidance form BS 8558, and BS5422.

CONCEALED PIPEWORK

The flexibility of Speedfit Pipe gives it the ability to be threaded through concealed or inaccessible spaces without disruption to surrounding structures, making major savings in installation time.

Pipework can be "cabled" through drilled holes in joists and rafters. Therefore, pipework can be installed after floorboards have been laid, working below the floor before the ceiling is installed.

This makes site work far safer as the installer does not have to balance on open joists with the risk of dropping tools or equipment on other people below.

This will also eliminate the risk of damage by floorboard nails. There is no need for dry runs since pipe can be cut and connections made in-situ.

Rigid pipe, such as copper, can only be fed under floor in short lengths. However, Speedfit Pipe, being flexible, can run from one fitting to another without having to install a connector in between.

Speedfit needs no jointing materials, eliminating the risk of fire from the use of a blowlamp, solder and flux.

TRADITIONAL JOISTS

Instructions on the drilling of joists is given in the Building Regulations Approved Document A, and summarised as follows:

1. Holes should be no greater than 0.25 of the depth of the joist.
2. Holes should be drilled at the neutral axis.
3. Holes should not be less than 3 diameters (centre to centre) apart.
4. Holes should be located between 0.25 and 0.4 times the span from the support.

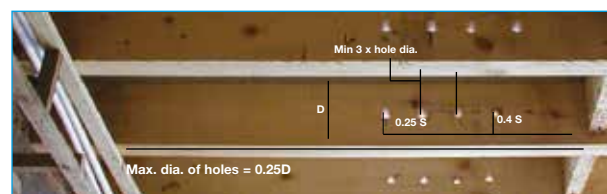

TIMBER I BEAM JOISTS

Several types of joists are available and Speedfit recommends that specific manufacturers details are consulted. However, the following can be used for general guidance.

- Holes may be located vertically anywhere in the web, but leave 3mm web at the top and/or bottom of hole. Do not cut into joist flanges when cutting the web.
- If more than one hole is to be cut in the web, the distance between the edges of the holes must be at least 2x diameter of the largest hole.
- Generally joists are manufactured with 38mm perforated knockouts in the web at approximately 300mm centres along the length of the joist.

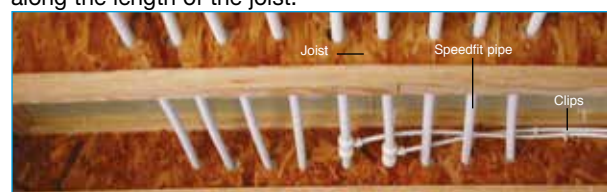

CROSS WEB JOISTS

Unlike I beam joists, pipe can be cabled anywhere within the open Web as no drilling is required. However, the top and bottom flanges must not be notched. Avoid damaging the outside diameter of the pipe as you cable through the metal cross web members.



TIMBER FRAMED CONSTRUCTION

Speedfit is well suited for timber frame construction. Ensure that the structural integrity is not compromised when installing the pipework. If the pipe passes through an external wall, care must be taken not to damage the vapour barrier and should be installed on the inside of the thermal insulation layer.

If this is not possible, the use of conduit should be specified at the design stage.

STEEL FRAMED CONSTRUCTION

Speedfit is well suited for steel frame construction and care should be taken when installing the pipework. All runs should be installed through preformed holes in the structure and protected by a rubber or plastic grommet.

Where clipping of pipework is restricted, cable ties may be used to secure the pipe. As with all installations, make sure that any pipework passing through walls and floors does not affect the fire resistant properties of the structure.

DRY LINED WALLS

Speedfit Pipework can be easily cabled through studwork and within wall systems as well as behind "dot and dab" plasterboard installations. Speedfit 10mm Barrier Pipe is most commonly used to feed radiators. If incorporating fittings in this way, collet covers or collet clips must be used with the **Standard** Range of Fittings.

WET PLASTER

To prevent surface damage to the plaster caused by expansion and contraction of Speedfit Pipes, it is important to ensure that all Speedfit Pipework is channelled into the wall and protected with appropriate sleeving. Alternatively, the pipework can be surface mounted and boxed in if required for aesthetic appearance.

LAYING OF PIPE IN CONCRETE AND MASONRY

Speedfit Pipe and Fittings can be laid in concrete and masonry providing they are installed in conduit pipe with access boxes for the fittings. As stated in Water Regulation Schedule 2.7 and BS 8000 : Part 15, fittings and pipe should be removable for possible replacement. Insulation is also recommended to protect against heat loss and the effects of frost. Speedfit Conduit Pipe is in either 15mm or 22mm in coil lengths of 25m or 50m. The flexible convoluted pipe has an outside diameter of 24mm and 30mm.



EXPOSED PIPEWORK

On long exposed runs of pipework, the expansion of Speedfit Pipe when warm (1% on length between 20 to 82°C) can cause it to sag between clip fixings. When this is undesirable, pipework can be boxed in or replaced with rigid copper pipe.

Speedfit Pipe and Fittings are stabilised to withstand limited exposure to ultra-violet radiation in sunlight but are not designed for permanent direct exposure. Under such conditions painting or lagging is required. Pipe and fittings should also be lagged to prevent frost damage.

CHEMICAL EFFECTS

Only water or oil based paints should be used. Do not allow Speedfit fittings to come into contact with jointing compounds, cellulose based paints, paint thinners or strippers, solder flux, acid based descalents or aggressive cleaning products including those below pH4, high in hypochlorite (e.g. bleach) or containing hydrogen peroxide. (See the DISINFECTION OF HOT AND COLD WATER SYSTEMS section of the installation advice for specifically permitted disinfection procedures).

If there is a risk of any chemical treatments coming into contact with Speedfit, please contact the Technical Advisory Service first to check compatibility.

FLUXES AND SPEEDFIT

JG Speedfit does not recommend that fluxes of any type come into contact with our pipe and fittings. However, if fluxes are to be used in an environment where Speedfit is installed then we recommend installers use non-acidic and zinc chloride free fluxes such as Fernox Flux.

ACOUSTIC

Properly installed, Speedfit Pipes are virtually silent in operation and do not resonate; they absorb the acoustic vibrations and pressure waves created by cavitations, water hammer, float operated valve oscillation and other hydraulic effects. The inherent flexibility of Speedfit Pipe effectively eliminates these troublesome problems, including those that occur when, due to thermal expansion, metal pipes rub against structural members and where long, straight runs of rigid pipe amplify water borne noise.

PROTECTION AGAINST RODENTS

When used in locations vulnerable to rodent attack, all plastic pipes and fittings should be adequately protected within sealed ducts. Speedfit Products along with other materials such as electrical cables may be damaged if rodents are present. If vermin infestation is suspected then a rodent exterminator should take appropriate action.

BIOLOGICAL

No taste, colour, odour or toxicity is imparted to water by Speedfit Components, nor do they promote microbiological growth. In accordance with BS7291 Part 1 requirements, the opacity of both pipes and fittings allows insufficient light to pass for the growth of algae. Tests within the Water Regulations Advisory Scheme, have approved Speedfit Pipe and Fittings to BS 6920 for water quality.

SYSTEM TESTING

On completion of the plumbing and heating system it is essential that system checking and a hydraulic wet test takes place. Connections to boilers, radiators and sanitary ware should first be capped or plugged. Testing should be carried out at 2 bar for 10 minutes followed by 10 bar for 10 minutes. This testing combined with other relevant checks, should reveal most system problems. Any components within the system not designed to take these pressures should be disconnected.



Before carrying out a pressure test ensure all Speedfit Pipe and fittings are installed correctly. Speedfit Barrier Pipe is printed with insertion marks to help ensure full insertion has been achieved.

Remember pressure testing is **NOT** a substitute for making sure fittings are clean and free of any grit, dirt or swarf and the pipe is correctly inserted (see Making a Good Connection).

SYSTEM COMMISSIONING AND FLUSHING

With existing systems, flushing prior to the use of Speedfit is essential to remove any harmful contamination or chemical residues from elsewhere in the system.

For the installation of central heating systems flushing procedures must be in line with BS7593 code of practice for treatment of water in domestic hot water heating systems. Flux residues used in the soldering of capillary fittings are very corrosive. Dirt and grit, which can enter the system when Speedfit Pipe is being pushed through underfloor or across a roof space, must be removed.

During the commissioning of a heating system, all air must be removed from the system before the boiler is allowed to fire. This will ensure pockets of air do not cause localized overheating within the system as this could have a detrimental affect on the pipework and boiler. For further advice on chemical flushing agents and inhibitor treatments, the following manufacturers should be contacted: Fernox Manufacturing Ltd, 0330 100 7750 or Sentinel BetzDearborn Ltd, 0151 424 5351 or Adey Innovations LLP on 01242 546717.

DISINFECTION OF HOT AND COLD WATER SYSTEMS

Speedfit can be disinfected with chlorine (sodium hypochlorite) after installation. Domestic systems are disinfected with a solution of chlorine with a concentration of 50ppm (mg/l) for one hour. The concentration should not be less than 30ppm at all draw off points after this time.

Other disinfection methods and chemicals (e.g. ozone and hydrogen peroxide) are now in common use. Only those specifically recommended as suitable for contact with plastic plumbing systems and, where necessary, employing specialist contractors may be used with Speedfit.

Disinfection solutions must only come into contact with the internal (wet) surfaces of the system. If any normally dry surfaces of a Speedfit fitting come into contact with disinfection solution the whole fitting must be replaced immediately. The disinfection solution must be immediately flushed out at all draw off points with fresh, wholesome water at the end of the disinfection period.

The solution must not be left in the system.

TECHNICAL ADVISORY SERVICE

The JG Speedfit Technical Advisory Service is available to assist and advise on all aspects of using the Speedfit system. The service is available between 8.00am and 5.00pm, Monday to Friday on Telephone No. 01895 425333 and Fax No. 01895 425350. Products within this Product Guide are designed for use within UK plumbing and heating installations or in other countries where similar installation requirements apply. For information on products suitable for use in other countries please consult our Technical Advisory Service.

We take pride in the quality of our products and all complaints are investigated thoroughly. If you have a problem with a Speedfit Product please return both fitting and pipe to us for investigation. We will need at least 50mm of pipe to ensure an accurate analysis. If there is a suspicion that the pipe is faulty, please provide marking details from the pipe.

METAL FOIL TAPE

JG Speedfit aluminium Foil Tape can be used to fulfil the NHBC requirements for the identification of location of plastic pipes in or behind a wall surface by a metal detector. It features a bright aluminium finish, rubber/resin high-tack adhesive and quality siliconised backing paper to allow the easy handling of short, cut lengths.

DO NOT stick the tape to the Speedfit pipe or fittings or those of any other manufacturer.

COMMON PROBLEMS AND IDENTIFICATION

Problem : Burst or melted pipe.

Pipe will be distorted showing either a 'Parrot beak' look or a long opening with the edges of the pipe melted in a wave shape.

Identification : A 'Parrot beak' will have been formed by the pipe bursting due to the water freezing. If the Pipe has a melted appearance it will have been subject to a temperature in excess of 128°C. This will have been caused by direct contact with a heat source such as a blowtorch or flue pipe or by water or steam within the system rising above safety levels.

Problem : A fitting or part of a fitting dissolved - the fitting may have blown off the pipe and may have missing component parts.

Identification : The fitting will have failed because of a chemical attack. The most common attack is from acid based solder flux running down into the fitting during soldering of a nearby copper fitting or flux coming into contact with the fitting in some other way.

Problem : Weep from fitting.

Identification : The pipe has not been fully inserted up to the pipe stop or one or both of the 'O' rings have been damaged by burrs or sharp edges on the end of pipe. See 'What Not to Do' on page 04.

Problem : The fitting has blown off the pipe. Fitting is missing the collet, the pipe insert is still inside the fitting after the pipe has come out.

Identification : If this happens on first fix, the most likely reason is that the pipe has not been fully inserted into the fitting, up to the pipe stop, and the system has not been pressure tested.

If the collet (gripping device) is missing everything will blow out. If the collet is there and the pipe support is still inside the connector but the pipe has still blown out, this means that full insertion had not been accomplished.

UNDERFLOOR HEATING

The Speedfit Underfloor Heating System has been designed to be quick and easy to install with components designed and manufactured to ISO9001 and DIN4726.

The Speedfit System has hot water pumped from a boiler to a pump pack, where it is mixed to approximately 50°C then distributed via a manifold to heating circuits made using Speedfit Barrier Pipe.

In concrete floors, the pipe is laid on insulation and then covered with a screed on which can be laid almost any type of floor covering.

For timber floor, spreader plates are laid between the joists and the floor decking or on the underside of the floor. Speedfit Pipe is pushed into the grooves on the plates.

The floor area is typically warmed to between 25°C and 28°C, providing an even distribution of heat at only slightly higher than room temperature.

A wide range of electrical components means The System can have as much or as little control as required.

TECHNICAL CHECKLIST

The Technical Checklist for Underfloor Heating Products is on page 39.

SPEEDFIT SUPPORT

JG Speedfit Underfloor offers a range of products to ensure that a wide variety of project types and sizes can be catered for. All pipe connections are made with a Speedfit push-in connection and the new JG Layflat pipe system has made fixing plastic pipe a far easier experience.

Speedfit Support's national team of technical engineers is available to help you get the best from your Speedfit System, be it assistance or advice.

Their service includes a free underfloor heating estimate, onsite installation advice, a technical helpline and a free CAD design service.

Technical Help Desk: 01895 425333
8am to 5pm Monday through Friday

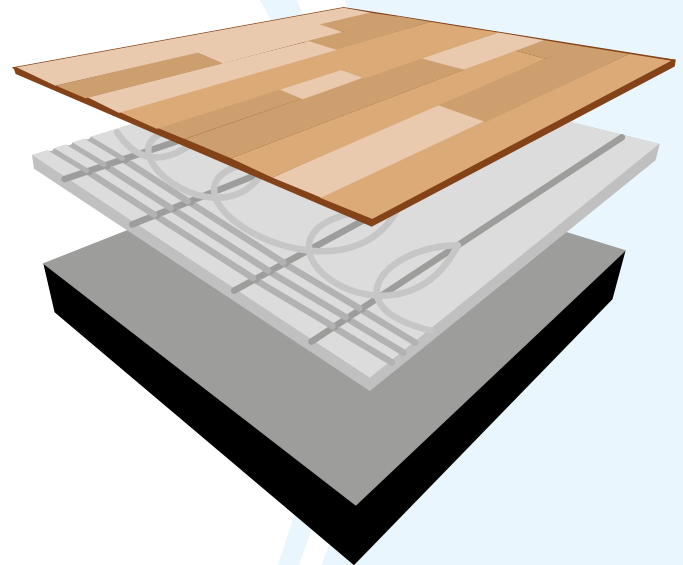

With you every step of the way



Instant Estimate



Free Design With Quote



Support On your Doorstep



Technical Helpline



Install Videos & Guides

MANIFOLDS AND PIPE FIXING SYSTEMS

MANIFOLD - STAINLESS STEEL

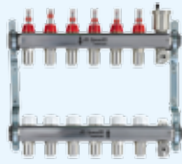

PART No.	DESCRIPTION	PACK QTY
JGUFHMAN2/2	2 Zone	1
JGUFHMAN3/2	3 Zone	1
JGUFHMAN4/3	4 Zone	1
JGUFHMAN6/3	6 Zone	1
JGUFHMAN8/3	8 Zone	1
JGUFHMAN10/3	10 Zone	1
JGUFHMAN12/3	12 Zone	1

The manifolds are complete with adjustable flow gauge, drain valve and air bleed valve. They are pre-assembled on wall brackets and supplied with screws and plugs. Also supplied with 'STS' Pipe Inserts and Collet Clips.

THERMOMIX CONTROL PACK - NICKEL PLATED



PART No.	DESCRIPTION	PACK QTY
JGCONTROL/4	CONTROL PACK	1



ACTUATOR VALVE



PART No.	DESCRIPTION	PACK QTY
JGUFHA(240V)/2	240 v Circuit Actuator Valve	1



MANIFOLD EXTENSION KIT - NICKEL PLATED



PART No.	DESCRIPTION	PACK QTY
MEKIT01/2	Manifold Extension Kit	1

MANIFOLD ELBOW CONNECTOR - NICKEL PLATED



PART No.	DESCRIPTION	PACK QTY
JGUFHMANELB/2	Manifold Elbow Connector	1

CONDUIT ELBOW



PART No.	DESCRIPTION	PACK QTY
JGUFHCONELB	Conduit Elbow	50

SPREADER PLATES

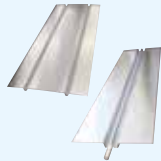

PART No.	SIZE MM x MM	PACK QTY
JGUFHSP400	390 x 1000	10
JGUFHSP250	390 x 250	10
JGUFHSP165	FOR I BEAM JOISTS 165 x 1000	20

Available in Pack Multiples only.

Layflat Pipe Lays Flat - Stays Flat - Ultra Flexible JG LAYFLAT® POLYBUTYLENE BARRIER PIPE

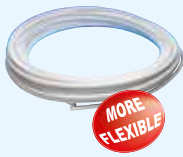

MORE FLEXIBLE

PART No.	SIZE MM x M	PACK QTY	Box QTY
15BPPB-50C	15 x 50	1	6
15BPPB-100C	15 x 100	1	4
15BPPB-120C	15 x 120	1	4
15BPPB-150C	15 x 150	1	3
15BPPB-300C	15 x 300	1	

SPEEDFIT PEX BARRIER PIPE



PART No.	SIZE MM x M	PACK QTY	Box QTY
15BPEX-50C	15 x 50	1	5
15BPEX-100C	15 x 100	1	5
15BPEX-120C	15 x 120	1	5
15BPEX-150C	15 x 150	1	4

PIPE STAPLES

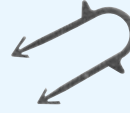

PART No.	DESCRIPTION	SIZE	PACK QTY
JGUFHSTAPLE	Pipe Staples	60mm	300
JGUFHSTAPLE40	Pipe Staples	40mm	300

STAPLE GUN

NEW LOWER PRICE



PART No.	DESCRIPTION	PACK QTY
JGUFHGUN	Staple Gun	1

MOUNTING RAIL



PART No.	DESCRIPTION	PACK QTY
JGUFHRAIL	2 Metre Long	16
JGUFHPIN	Rail Pins For Above	100

Available in Pack Multiples only.

FLOOR CLIPS



PART No.	DESCRIPTION	PACK QTY
JGUFHCLIP	Floor Clip	100

Available in Pack Multiples only.

FIXING TOOL



PART No.	DESCRIPTION	PACK QTY
JGUFHTOOL	For Easy Fixing Of Floor Clips	1

EDGE STRIP



PART No.	DESCRIPTION	PACK QTY
JGUFHEDGE	25 Metre Roll	1

OVERFIT® BOARD



PART No.	DESCRIPTION MM X MM	PACK QTY
JGUFHBOARD1	Overfit Board 1250 x 600	10

Used to install underfloor heating pipe over an existing floor structure.

UNDERFIT® BOARD

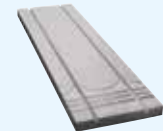

PART No.	DESCRIPTION MM X MM	PACK QTY
JGUFHBOARD2	Underfit Board 1200 x 350	10

Used to install underfloor heating pipe between existing joists.

PRE-GROOVED TRANSITION BOARD

NEW

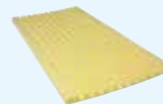

PART No.	DESCRIPTION MM X MM	PACK QTY
JGUFHBOARD3	Pre-grooved Transition Board 1250 x 600	5

Used for the transfer of pipes from manifold to rooms intended to heat.

FLOOR PANELS

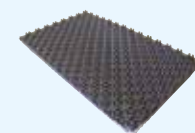

PART No.	DESCRIPTION MM X MM	PACK QTY
JGUFHTILE	Floor Tile 1400 x 800	12

Supplied in packs of 12, Speedfit Floor Tiles have an 11mm layer of insulation for support and additional thermal insulation.

UNDERFLOOR



Ultimate control at your fingertips

JG Aura is the new heating control concept from JG Speedfit, which allows for a more flexible and efficient remote regulation of your underfloor and central heating system as well as individual radiator control.

The JG Aura system provides you with the capability of controlling multiple zones. This enables the home owner to set heating time and temperature within each individual room resulting in considerable energy savings.

The range consists of 230v mains powered controls including a wireless range that can be controlled by your smart phone, tablet and computer via the JG Aura app.

For greater convenience, be it a new build or retrofit project, thermostats can be battery powered or if preferable wireless thermostats can be mains power supplied.

The new JG Aura controls present beautiful styling, touch sensitive control whilst incorporating high level functionality ultimately defined by the unique pioneering 4-in-1 JG Aura thermostat.

WHY JG AURA IS AHEAD OF THE REST

- Smart App control at your fingertips
- Unique '4-in-1' Thermostat
- Slimline design, touch sensitive control
- Energy saving
- 5 Year Guarantee

Energy Saving Trust (EST) is a British organisation devoted to promoting energy efficiency, energy conservation, and the sustainable use of energy, thereby reducing carbon dioxide emissions and helping to prevent man-made climate change.



Products marked with '•' have been awarded the EST marquee.



JG AURA WIRELESS RANGE

The unique JG Aura 4-in-1 wireless thermostat is designed to present wireless control of your underfloor heating system including unique wireless boiler communication when installing the JG Aura boiler receiver. The thermostat can operate as a [Programmable Room Thermostat](#), [Group Control Thermostat](#), [Group Thermostat](#) and a [Hot Water Timer](#).

The JG Aura wireless thermostat is designed to work with the JG Aura app when incorporating the internet hub, presenting you ultimate control of time and temperature, underfloor heating and hot water wherever you are in the world.

The stylish slim line thermostats offer touch sensitive control at your fingertips. Uniquely, the installer is presented with two options of powering the thermostat, either with batteries or simply mains powered.

• JG AURA WIRELESS THERMOSTAT - 230V



PART No.	DESCRIPTION	BOX QTY
JGSTATW2W	Wireless Stat (230v) - White	1
JGSTATW2B	Wireless Stat (230v) - Black	1

• JG AURA WIRELESS THERMOSTAT - BATTERY



PART No.	DESCRIPTION	BOX QTY
JGSTATW1W	Wireless Stat (Battery) - White	1
JGSTATW1B	Wireless Stat (Battery) - Black	1

JG AURA HUB



PART No.	DESCRIPTION	BOX QTY
JGHUB2	JG Hub 1-30	1

JG AURA WIRELESS COORDINATOR



PART No.	DESCRIPTION	BOX QTY
JGCO	Wireless Coordinator	1

JG AURA WIRELESS BOILER RECEIVER



PART No.	DESCRIPTION	BOX QTY
JGBR	Boiler Receiver	1

JG AURA WIRELESS 8 ZONE WIRING CENTRE



PART No.	DESCRIPTION	BOX QTY
JGWCW	Wireless 8 Zone Wiring Centre	1

JG AURA HUB USER LICENCE



PART No.	DESCRIPTION	PACK QTY
JGHUB1	JG Hub User Licence	1

PROBE



PART No.	DESCRIPTION	PACK QTY
JGPRB	Probe	1

PROBE BOX



PART No.	DESCRIPTION	PACK QTY
JGSB	Probe Box	1

NEW JG AURA WIRELESS TRV

The JG Aura Wireless TRV simply replaces the manual standard radiator valve head and in doing so, opens up new possibilities for energy saving.

Combining the TRV with JG Aura Wireless Thermostats and JG Aura Coordinator, users can turn individual radiators on or off as well as remotely controlling your boiler at the same time. This allows for potentially significant energy savings as you only heat rooms that are in use and do not waste energy in unoccupied rooms.

The JG Aura Wireless TRV can be combined with underfloor heating systems and is very simple to install. Every installation will require a JG Aura Wireless Controlling Thermostat and a JG Aura Boiler Receiver.

The Wireless TRV system can be internet enabled by installing a JG Aura Hub and JG Aura Coordinator.

• JG AURA WIRELESS TRV



PART No.	DESCRIPTION	PACK QTY
JGTRV	Wireless TRV	1

JG AURA APP

For use with JG Aura Wireless Range



The JG Aura App gives you the freedom to control your heating, no matter where you are via smart phone, tablet or desktop computer.

The easy to use interface and comprehensive nature of JG Aura, makes control of your heating system completely accessible from anywhere and at any time that suits you.

Don't worry if you have forgotten to turn off the heating when you leave for holiday as you can simply switch to Holiday Mode whilst in the departure lounge or on a sunbed.

Download the free App

The JG Aura App is compatible with iOS, Android and Windows Phone.



Disclaimer

Customers that choose to operate their heating remotely using JG Aura Range technology via their personal computer, tablet or smart phone device(s) will be entering into a contract with Salus Controls plc ("Salus"), which is a third party supplier of the software. John Guest Ltd and affiliates within the John Guest group of companies from time to time (the "John Guest Group") make no representations or warranties of any kind about the reliability or suitability of the software or applications provided by Salus. The John Guest Group disclaims liability (excluding liability for death and personal injury resulting from negligence) for any loss or damage caused by the software provided to customers by Salus. Any agreement entered into with Salus is therefore strictly at your own risk.



NEW JG AURA 230v RANGE

At the heart of the JG Aura 230v range is once again our unique 4-in-1 JG Aura thermostat, providing combined control of UFH and radiators allowing simple installation of multi zone energy saving systems in new or retrofit projects.

To enable the Group Control functionality it is essential that a 0.5mm 2 core data cable is utilised within the wiring process. The Group Control Thermostat can control a variation of both digital thermostats and dial thermostats from one central location. The optional data cable will not be required if the thermostats are to be used as individual Programmable Room Thermostats.

The Group Control Thermostat can control up to eight thermostats plus a hot water timer.

• JG AURA 230v THERMOSTAT



PART No.	DESCRIPTION	BOX QTY
JGSTAT2W	230v Thermostat & H/W - White	1
JGSTAT2B	230v Thermostat & H/W - Black	1

• JG AURA 230v DIAL THERMOSTAT



PART No.	DESCRIPTION	BOX QTY
JGSTAT1	230v Dial Thermostat	1

JG AURA 230v 8 ZONE WIRING CENTRE



PART No.	DESCRIPTION	QTY
JGWC	230v 8 Zone Wiring Centre	1

UNDERFLOOR HEATING FOR CONSERVATORIES AND EXTENSIONS

The Speedfit Underfloor Heating Control Unit is the ideal way to provide heating to a conservatory or room extension up to 30sqm.

The unit is pre-assembled and pre-wired to allow for a fast and simple installation. It can be plugged into any convenient electrical socket or spur.



Now featuring new JG Aura Underfloor Heating Controls

CONTROL UNIT



PART NO.	DESCRIPTION	PACK QTY
JGROOMPACK/2	Single Room Control Unit	1

For conservatories or room extensions up to 30m².

SINGLE ROOM UNDERFLOOR HEATING PACK



PART NO.	DESCRIPTION	PACK QTY
JGUFHPACK20/3	Underfloor Heating Pack	1

For conservatories or room extensions up to 20m².

Pack contains:

- 1 x 15mm x 150m Coil of Pipe
- 1 x Single Room Control Unit
- 1 x JG Aura Programmable 230v Room Thermostat
- 200 x 15mm Pipe Clips
- 2 x 15mm Pipe Inserts



PART NO.	DESCRIPTION	PACK QTY
JGUFHPACK30/3	Underfloor Heating Pack	1

For conservatories or room extensions up to 30m².

Pack contains:

- 2 x 15mm x 100m Coils of Pipe
- 1 x Single Room Control Unit
- 1 x JG Aura Programmable 230v Room Thermostat
- 300 x 15mm Pipe Clips
- 8 x 15mm Pipe Inserts
- 2 x 15mm Speedfit Equal Tees
- 2 x 15mm Speedfit Stem Elbows

WIRELESS SINGLE ROOM UNDERFLOOR HEATING PACK



PART NO.	DESCRIPTION	PACK QTY
JGUFHWPACK30/3	Wireless Underfloor Heating Pack	1

For conservatories or room extensions up to 30m².

Pack contains:

- 1 x Control Unit
- 1 x JG Aura Wireless Programmable Room Thermostat
- 1 x Wireless Boiler Receiver
- 1 x Wireless Coordinator
- 2 x 15mm x 100m Coils of Pipe
- 300 x Pipe Clips
- 8 x Pipe Inserts
- 2 x 15mm Speedfit Equal Tees
- 2 x 15mm Speedfit Stem Elbows
- 1 x 2 Zone Wireless Receiver

Please Note: The additional purchase of the JG Hub will allow Internet Facility.

UNDERFLOOR HEATING SPARE PARTS

Spare parts listed below in 2 tables. They relate to manifolds launched on April 1st 2014 which can be identified with the red flow gauges. Items listed as prior to April 2014 refer to previously available manifolds.

SPARE PARTS FOR MANIFOLDS LAUNCHED APRIL 2014

PART No.	DESCRIPTION
MKIT01	Manifold Flow Meter
MKIT02	Manifold Circuit Isolating Valve
MKIT03	Decorators Cap Return Manifold
MKIT04	Drain Valve
MKIT05	Auto Air Vent
MKIT06	Manual Air Vent
MEKIT01	1 Port Manifold Extension
MVKIT01	22mm Angle Ball Valve
MVKIT02	22mm Straight Ball Valve
MVKIT03	Service Kit for JGCONTROL/4
PUMP-GA	6M 'A' Rated Grundfords Pump

SPARE PARTS FOR MANIFOLDS PRIOR TO APRIL 2014

PART No.	DESCRIPTION
SPUFH7	Manifold Ball Valve - Red
SPUFH8	Manifold Ball Valve - Blue
SPUFH9	Drain/Filling Valve
SPUFH10	Manifold Flow Meter
SPUFH11	Manifold Isolating Valve
SPUFH13	UFH Air Vent
SPUFH14	PTFE Washer
SPUFH15	Service Kit - JGCONTROL/2
SPUFH16	Service Kit - JGROOMPACK
SPUFH17	Connection Box - STAT
JGUFHMANEXT/2	Manifold Extension Kit

TECHNICAL CHECKLIST - PLUMBING AND HEATING FITTINGS

Fittings and pipe should be kept clean and undamaged before use.

- **Sizes.** 10mm to 28mm diameter.
- **Pipes.** Speedfit fittings can be used with:
 - Copper pipe to BS EN 1057
 - Speedfit Barrier Pipe to BS7291

Speedfit fittings cannot be used on stainless steel pipe.

- **Standards.** Speedfit products are designed and manufactured under a fully integrated system assessed by B.S.I. to BS EN ISO9001 and are approved by the Water Regulations Advisory Scheme. Speedfit 'PEM', 'PSE' and 'SFM' Fittings and Speedfit Barrier Pipe are Kitemarked to BS7291 Parts 1, 2 and 3 Class S (Licence No. KM39767).

- **Applications**
 - Mains fed and indirect cold water systems
 - Vented and unvented hot water systems
 - Vented and sealed central heating systems

- **DO NOT USE FOR Gas, fuel oil or compressed air applications.**

- **Working Temperatures and Pressures.**

Application	Usual working temperature, °C	Maximum working temperature, °C	Maximum working pressure, bar
Cold Water (indirect and direct mains)	20	20	12
Central Heating	82	105, short term malfunction at 114	3
Hot Water (including unvented cylinders)	65	95	6

- **Burst Pressure (fittings).** With copper or plastic pipe at 20°C: Speedfit fittings used with copper or Speedfit Barrier Pipe will withstand pressures well in excess of normal service conditions.

- **High Temperatures.** Can withstand 114°C intermittently for short periods. The Speedfit system should not be used on an uncontrolled heat source.

- **Insulation.** Should comply with BS EN 806 and complimentary guidance document BS 8558, and BS5422, as for copper.

- **Minimum Bend Radii (BPEX)**

Pipe Diameter	10mm	15mm	22mm	28mm
Min radius with clips	100mm	175mm	225mm	300mm
Min radius with cold forming bend	30mm	75mm	110mm	-

- **Minimum Bend Radii (BPP)**

Pipe Diameter	10mm	15mm	22mm	28mm
Min radius with clips	80mm	120mm	176mm	-
Min radius with cold forming bend	30mm	75mm	110mm	-

- **Clip Spacing (in mm) For Surface Mounted Pipes**

Pipe Diameter	Clip Spacing	
	Horizontal Run	Vertical Run
10-15mm	300mm	500mm
22mm	500mm	800mm
28mm	800mm	1,000mm

Where pipe is concealed, clipping may only be required where necessary.

- **Expansion (PEX pipe).** 1% on length between 20°C and 82°C.

- **Flow Rates.** Comparable with metal systems.

- **Cleaners, Inhibitors and Descalents.** For advice on the replenishment of additives such as corrosion inhibitors, the following manufacturers should be contacted: Fernox Manufacturing Limited on 0330 100 7750, Sentinel BetzDearborn Limited on 0151 424 5351 or Adey Innovations LLP on 01242 546717.

- **Paint and Chemicals.** Use only water or oil based paint. **DO NOT ALLOW CONTACT WITH** jointing compounds, cellulose based paints, paint thinners or strippers, solder flux, acid based descalents or aggressive cleaning products, including those below pH4, high in hypochlorite (e.g. bleach) or containing hydrogen peroxide. (See the DISINFECTION OF HOT AND COLD WATER SYSTEMS section of the Product Guide installation advice for specifically permitted disinfection procedures).

- **Solder Flux.** No fluxes of any types should come into contact with JG Speedfit Pipe and Fittings. If fluxes are to be used in an environment where Speedfit is installed, then (1) extreme care should be taken to ensure that no such contact takes place and (2) JG recommend installers only use fluxes tested and approved in writing in advance by JG. At the date of this publication, the only such approved flux is Fernox Flux.

- **Chlorine.** Speedfit is not suitable for use in systems where the water contains high levels of chlorine. e.g. swimming pools, fountains etc.

- **Exposure to Sunlight.** Speedfit products, when used indoors, are not affected by sunlight. When used outdoors protect from ultra violet light by lagging or painting.

- **Pipe Clips.** Pipe clips should not be fitted any closer than 60mm from the end of the fitting. Pipe should be adequately supported by pipe clips to prevent undue stress (side load) on fittings.

- **Pipe Inserts.** Must be used on all installations when using plastic pipe and should be fully inserted. Only use a Speedfit Insert with Speedfit Pipe.

- **Metal Joists.** When 'cabling' plastic pipe through metal joists ensure rubber grommets are in place to prevent damage to pipe. Use of collet covers or collet clips on fittings recommended.

- **Connection to Boilers.** A minimum 1 metre run of copper pipe must be installed between the boiler and the Speedfit system, as per BS5955: Part 8.

- **Connection to Copper Pipe.** 450mm is the minimum distance to make a solder connection on copper pipe inserted into a Speedfit Fitting. Ensure that any residual flux and solder does not come into contact with the fitting.

- **Concrete and Masonry.** Speedfit pipe and fittings can be laid in concrete and masonry providing they are installed in conduit pipe with access boxes for the fittings. This is to enable the pipe to expand and to provide accessibility for both pipe and fitting. As stated in Water Regulation Schedule 2.7 and BS8000: Part 15, fittings and pipe should be removable for possible replacement. Insulation is also recommended to protect against heat loss and the effects of frost.

- **Electrical Continuity.** If Speedfit is used in an existing metal system which may have been used for earthing, electrical continuity should be reinstated.

- **Valves and Taps.** Plastic 15mm and 22mm valves and taps available from JG Speedfit Ltd are not suitable for central heating installations.

- **1/4 Turn Valves.** These valves have been designed to allow temporary servicing of downstream equipment and must only be used in the fully open or fully closed position.

Do Not use these Valves:

- In a partially open position to control flow.
- To provide a permanent termination.
- Without tubing assembled or plugged (or threaded connections sealed).
- As a tap or "faucet".

- **Collet Covers.** Collet covers provide added security against pipe disconnection, e.g. the fittings coming into contact with rigid surfaces and behind dry-lining walls. They are offered in white as standard and in red or blue to provide colour coding of pipe.

- **Collet Clips.** White and Grey collet clips are used with standard fittings to prevent accidental pipe disconnection. Red or blue clips provide colour coding of pipe. Red and blue clips should not be used to prevent accidental release of pipe.

- **Continuously Operated Re-Circulating Systems (Secondary Hot Water Circulation/Ring Main Installations):** A continuously operated re-circulating system is a water-replenished circulating system which is maintained at a constant high temperature to provide a constant source of hot water. Continuously operated re-circulating systems are used to distribute constant hot water to draw off points that may be distant from the source or hot water storage vessel. Continuously operated re-circulating systems are very different from conventional hot water supply and central heating systems found in domestic properties, for which our products have been tested to, under either BS7291 2010 Class S or WRAS approval standards, and for this reason Speedfit products must not be used on any continuously operated re-circulating systems as they are not approved under the current version of these standards.

- **System Testing.** To ensure the pipework and fittings have been installed correctly, whether it be on a new or extended system, it is essential that the system is checked and hydraulically wet tested. Testing should be at 2 bar for 10 minutes and 10 bar for 10 minutes. This testing, combined with other relevant checks, should reveal installation problems and is regarded as good plumbing practice. Speedfit Stop Ends and Plugs are particularly useful during this operation, enabling all outlets and any fittings to be easily plugged. However, system testing should not be regarded as a substitute for correct installation. See also "Making a Good Connection".

- **System Flushing.** As is usual practice for any plumbing installation, flushing of the system prior to the use of Speedfit is recommended to remove any contaminants/chemical residue from elsewhere in the system.

- **British Gas Service has accepted the John Guest Speedfit fittings as being suitable for open vented and sealed central heating systems and as eligible for acceptance onto its service contracts.**

- Products within this Price List are designed for use within UK plumbing and heating installations or in other countries where similar installation requirements apply. For information on products suitable for use in other countries please consult our Technical Advisory Service.

- **Vermin.** Speedfit products should not be used in vermin infested areas.

- **Maximum Torque Figures (BSP & BSPT).** Plastic threads are not generally as strong as brass threads. Customers and end users should be aware of this when choosing products for their applications. Overtightening of plastic threads will cause undue stress and eventual cracking and leakage. The maximum torque figures for BSP and BSPT threads used on Speedfit plumbing products in mating threads conforming to relevant BS or International thread standards are shown below.

Threads	Size	Maximum Torque
Plastic	1/2"	3.0 Nm
	3/4"	4.0 Nm
Brass	1/2"	4.0 Nm
	3/4"	5.0 Nm

It is recommended that all installations are checked prior to use to determine that a seal has been made.

- **Side Loads.** John Guest products are not designed to be used whilst under side load as this may adversely affect their ability to function long-term. Always ensure tubes have good alignment with the fitting. They must also not be subjected to any form of impact or other damage, such as being hit or dropped, even accidentally. If fittings have been damaged or suffered an impact, they should be replaced immediately. John Guest warranty does not cover loss caused by any form of damage.

TECHNICAL CHECKLIST - UNDERFLOOR HEATING

- **Applications.** Underfloor Heating Installations in solid or timber floors.
- **Pipes.** 15mm JG Speedfit Barrier Pipe to BS 7291, Parts 1, 2 and 3 Class S.
- **DO NOT USE Speedfit UFH Products for Gas, Fuel Oil or Compressed Air Applications.**
- **Floor Insulation.** Should be a suitable material and thickness to comply with current regulations.
- **Minimum Bending Radii.** For Speedfit B-PEX Pipe is 175mm.
- **Expansion (PEX - Pipe).** 1% on length between 20°C and 82°C.
- **Cleaners, Inhibitors and Descalents.** For advice on the replenishment of additives such as corrosion inhibitors, the following manufacturers should be contacted Fernox Manufacturing Limited on 01799 550811 or Sentinel, BetzDearborn Limited on 0151420 9595.
- **Paint and Chemicals.** Only use water or oil based paint. DO NOT ALLOW CONTACT WITH cellulose based paints, paint thinners or strippers, solder flux or acid based descalents or aggressive household cleaning products.
- **Exposure to Sunlight.** Speedfit products, when used indoors, are not affected by sunlight. When used out doors protect from ultra violet light by lagging or painting.
- **Pipe Inserts.** Must be used on all installations when using plastic pipe and should be fully inserted.
- **Electrical Components.** Electrical products in the Speedfit Underfloor Heating System are designed only to be used in U.K. Electrical Supply situations.
- **Electrical Continuity.** If Speedfit is used in an existing metal system which may have been used for earthing, electrical continuity should be reinstated.
- **Collet Clips.** White and Grey collet clips are used with standard fittings to prevent accidental pipe disconnection. Red or blue clips provide colour coding of pipe. Red and blue clips should not be used to prevent accidental release of pipe.
- **Pre-Screed System Testing.** To ensure the pipework has been installed correctly and prior to the screed being laid, it is essential that the system is checked and hydraulically wet tested.
Testing should be carried out at 2 bar for 10 minutes and 10 bar for 10 minutes.
This testing, combined with other relevant checks, should reveal installation problems and is regarded as good plumbing practice.
- **Pressurisation During Screed Laying & Curing.** In accordance with BS1264-4, the system should be left under pressure at a minimum of 6 bar for the duration of the laying and curing of the screed.
Under NO circumstances should the UFH System be used to quicken the screed drying process.
- **System Flushing.** As is usual practice for any plumbing installation, flushing of the system prior to the use of JG Speedfit is recommended to remove any contaminants/chemical residue from elsewhere in the system.
- **Vermin.** Speedfit products should not be used in vermin infested areas.
- **Frost Protection.** During the installation process it is important that pipe containing water be protected from frost.

TECHNICAL CHECKLIST - FITTINGS FOR COLD WATER SERVICES

- **Applications.** Speedfit Fittings for Cold Water Services are designed to connect MDPE pipes (MRS-PE80) used above or below ground, to convey potable water from distribution mains to individual properties.
- **Pipes.** The Fittings can be used with:-
- Blue MDPE pipe to BS6572.
- Black MDPE pipe to BS6730.
- Blue pipe to BS EN 12201-2, 20mm PN16, 25mm and 32mm PN12.5.
- **Adaptors.** Are available for:-
- Copper to BS EN1057 and PEX or PB to BS7291.
- Screwed pipe.
- LDPE to BS1972 Class C and Class D in 1/2" and 3/4" sizes.
- **Fittings for PEX and Copper Pipe.** Must not be buried into ground, soil, concrete or other substrates.
- **Working Temperatures and Pressures.** Maximum working pressure 16 Bar @ 20°C.
- **Standards.** The Fittings are approved by the Water Regulations Advisory Scheme.
- **Performance.** The fittings are manufactured from tough plastic material well able to meet the stringent requirements of the water industry. They have been approved by the WRAS and, as such, have passed the 'pull out test' where a force shown below is applied to a connection between MDPE pipes and a fitting for 5 minutes without the connection failing.
- **Chemical Effects.** For below ground applications the fittings require no additional preparations - coating etc. When used above ground, avoid contact with aggressive chemical compounds. Protect from frost where necessary. In the United Kingdom, potable water does not contain high levels of chemicals (eg chlorine etc) that would adversely affect Speedfit Underground Fittings.
- **Paint and Chemicals.** Use only water or oil based paint. **DO NOT ALLOW CONTACT WITH** jointing compounds, cellulose based paints, paint thinners or strippers, solder flux, acid based descalents or aggressive cleaning products, including those below pH4, high in hypochlorite (e.g. bleach) or containing hydrogen peroxide. (See the DISINFECTION OF HOT AND COLD WATER SYSTEMS section of the Product Guide installation advice for specifically permitted disinfection procedures).
- **Exposure to Sunlight.** Permanent exposure to direct sunlight will necessitate lagging the fittings.
- **Pipe Inserts.** Pipe inserts must be used and fully inserted on all connections to MDPE, LDPE, PEX or PB pipe.
- **System Testing.** Pressure test to 1.5 times working pressure for 10 minutes before connecting to the mains supply. It is recommended that all pipe and fitting installations are pressure tested after installation before handing over to the final user
- **Maximum Torque Figures.** The maximum torque figures for BSP and BSPM threads used on Speedfit products are as follows:-

Test Force	Size		
	20mm	25mm	32mm
Newtons	1900	2500	4100
lbs	427	562	921

Size	Maximum Torque
1/2	3.0 Nm
3/4	4.0 Nm

It is recommended that all installations are checked prior to use to determine that a seal has been made.

The maximum torque figures quoted for use with Speedfit fittings are dependent on the mating thread conforming to the relevant British International thread standards.

NUMERICAL INDEX

Part No.	Page Number	Part No.	Page Number	Part No.	Page Number	Part No.	Page Number	Part No.	Page Number
1/2EPW	16	22PTS	14	JGSTAT1	36	PEM0415WP	21	PSE4622WP	23
10EPR	16	22PTSVP	24	JGSTAT2B	36	PEM0422W	13	PSE4628W	14
10BPB-25C	15	22RA	16	JGSTAT2W	35	PEM0422WP	23	PSE4628WP	23
10BPB-50C	15	22REDCON-50C	15	JGSTATW1W	35	PEM0428W	13	PUMP-GA	37
10BPB-100C	15	22RKP	12, 22	JGSTATW2W	35	PEM0428WP	23	PXC10	16
10BPEX-25C	15, 24	22STV	13	JGSTATW1B	35	PEM061510W	14	PXC15	16
10BPEX-50C	15	22STVP	23	JGSTATW2B	35	PEM061510WP	24	PXC22	16
10BPEX-100C	15	22SV	14	JGTAPE	16	PEM062215W	14	PXC28	16
10BV	14	22SV-H	14	JGTHRAD15	14	PEM062215WP	24	SFM512210E	12
10CFB	16	22SVP	23	JGTRV	36	PEM062815W	14	SFM512210EP	22
10HSV	14	22TKP	12, 22	JGUFHA(240v)/2	34	PEM062815WP	24	SFM522210E	12
10HSVP	23	22WB	13	JGUFHBOARD1	34	PEM062822W	14	SFM522210EP	22
10MC(1/2)	13	28EPR	15	JGUFHBOARD2	34	PEM062822WP	24	SFM522215E	12
10RA	16	28BPEX-10X3L	15, 24	JGUFHBOARD3	34	PEM201510W	11	SFM522215EP	22
15APT	13	28BPEX-10X6L	15	JGUFHCLIP	34	PEM201510WP	21	SPF22	16
15APT2	13	28RA	16	JGUFHCONELB	34	PEM202215W	11	SPUFH10	37
15EPR	16	3/4EPW	16	JGUFHEDGE	34	PEM202215WP	21	SPUFH11	37
15ESOT	13	AM1915W	16	JGUFHGUN	34	PEM211510W	11	SPUFH13	37
15ESOTP	23	AM1922W	16	JGUFHMAN10/3	34	PEM211510WP	21	SPUFH14	37
15APT2P	23	ASV3	13	JGUFHMAN12/3	34	PEM212215W	11	SPUFH15	37
15APT	23	ASV4	13	JGUFHMAN2/2	34	PEM212215WP	21	SPUFH16	36
15BDC	14	CM-SC-15S	24	JGUFHMAN3/2	34	PEM221010W	11	SPUFH17	37
15BDCP	24	CM0715S	12	JFUFHMAN4/3	34	PEM221010WP	21	SPUFH7	37
15BLKCON-25C	15	CM0715SP	22	JGUFHMAN6/3	34	PEM221015W	11	SPUFH8	37
15BLKCON-50C	15	CM0722S	12	JGUFHMAN8/3	34	PEM221015WP	21	SPUFH9	37
15BLUCON-50C	15	CM0722SP	22	JGUFHMANELB/2	34	PEM221515W	11	STS10	15
15BPB-25C	15	CM0728S	12	JGUFHMANEXT/2	37	PEM221515WP	21	STS10P	24
15BPB-50C	15	CM1810B Blue	16	JGUFHPACK20/2	37	PEM222222W	11	STS15	15
15BPB-100C	15, 34	CM1810R Red	16	JGUFHPACK30/2	37	PEM222222WP	21	STS15P	24
15BPB-120C	15, 34	CM1810S Grey	16	JGUFHPIN	34	PEM3015AW	11	STS22	15
15BPB-150C	15, 34	CM1810W White	16	JGUFHRAIL	34	PEM3015AWP	21	STS22P	24
15BPB-25C	15	CM1815B Blue	16	JGUFHSP165	34	PEM3015BW	11	STS28	15
15BPB-300C	15, 34	CM1815R Red	16	JGUFHSP250	34	PEM3015BWP	21	TSM10N	15
15BPB-50C	15, 34	CM1815S Grey	16	JGUFHSP400	34	PEM302210AW	11	TSM10NP	24
15BPEX-100C	15, 34	CM1815W White	16	JGUFHSTAPLE	34	PEM302210AWP	21	TSM15N	15
15BPEX-120C	15, 34	CM1822B Blue	16	JGUFHSTAPLE40	34	PEM3022AW	11	TSM15NP	24
15BPEX-150C	15, 34	CM1822R Red	16	JGUFHTILE	34	PEM3022AWP	21	TSM22N	15
15BPEX-20X2L	15, 22	CM1822S Grey	16	JGUFHTOOL	34	PEM3022BW	11	TSM22NP	24
15BPEX-20X3L	15, 22	CM1822W White	16	JGUFHWPACK30/2	37	PEM3022BWP	21	TSM28N	15
15BPEX-25C	15, 22	CM2315W	12	JGWC	36	PEM3022CW	11	TSM28NP	24
15BPEX-50C	15, 24, 34	CM551516W	12	JGWCW	35	PEM3022CWP	21	UG063228B	26
15BPEX20X6L-B	15	CONLEB	16	MEKIT01	37	PEM3022DW	11	UG101B	26
15BPEX20X6L-R	15	FLX-BLU	18	MEKIT01/2	34	PEM3022DWP	21	UG102B	26
15BSC	14	FLX-RED	18	MKIT01	37	PEM302810AW	11	UG103B	26
15BSCP	23	FLX15P	17	MKIT02	37	PEM302815AW	11	UG104B	26
15BV	14	FLX16P	17	MKIT03	37	PEM302815AWP	21	UG201B	26
15BVP	24	FLX17P	17	MKIT04	37	PEM3028AW	11	UG202B	26
15CFB	16	FLX18P	17	MKIT05	37	PEM3028AWP	21	UG203B	26
15DCV	13	FLX19P	17	MKIT06	37	PEM3028BW	11	UG222025B	26
15DCVP	24	FLX20P	17	MVKIT01	37	PEM3028BWP	21	UG222525B	26
15DCSV	14	FLX21P	17	MVKIT02	37	PEM3028DW	11	UG223232B	26
15HSV	14	FLX22P	17	MVKIT03	37	PEM3028DWP	21	UG232AB	26
15HSV-BRASS	14	FLX23P	17	MW011504N	13	PEM532210W	11	UG301B	26
15HSVP	23	FLX24P	17	MW012206N	13	PEM532210WP	21	UG302B	26
15MC(1/2)	13	FLX25P	17	MW012808N	13	PEM532215W	11	UG303B	26
15MC(1/2)P	22	FLX26P	17	MW012818N	13	PEM532215WP	21	UG401B	26
15PIP-50C-E	15	FLX27P	17	MW051504N	13	PEM571515W	11	UG402B	26
15PTS	14	FLX28	17	MW052206N	13	PEM571515WP	21	UG403B	26
15PTSVP	24	FLX29	17	MW052818N	13	PEM572222W	11	UG4501B	26
15PWB	12	FLX31P	17	MW451514N	13	PEM572222WP	21	UG4502B	26
15RA	16	FLX32P	17	MW452216N	13	PEMBTC1014	12	UG4620B	26
15REDCON-50C	15	FLX33P	17	MW501514N	13	PEMBTC1014P	22	UG4625B	26
15RKP	12, 22	FLX34P	17	MW502216N	13	PEMBTC1514	12	UG501B	26
15STV	13	FLX35P	17	NC2324	24	PEMBTC1514P	22	UG502B	26
15STVP	23	FLX36P	17	NC2511	24	PEMSTC1014	11	UG601B	11, 26
15SV	14	FLX37-H	17	NC448	24	PEMSTC1014P	22	UG602B	11, 26
15SV-H	14	FLX37P	15	NC471	24	PEMSTC1514	13	UG603B	11, 26
15SVBTC	14	FLX38P	15	NC473	24	PEMSTC1514P	24	UG604B	11, 26
15SVBTC-W	14	FLX39-H	15	NC737	26	PEMSTC1516	13	UG801E	26
15SVBTC-WP	23	FLX39P	15	NPC10	16	PEMSTC1516P	24	UG802E	26
15SVBTC	23	FLX40P	15	NPC10P	24	PEMSTC2216	13	UG803E	26
15SVP	23	FLX41P	15	NPC15	16	PEMSTC2216P	24	UGICO1	26
15SVSTC	14	FLX42	15	NPC15P	24	PFLX15	20	UGIOC2	26
15SVSTC-W	14	FLX43P	15	NPC22	16	PFLX16	20	UGWB1514	12, 26
15SVSTC-WP	23	FLX44P	15	NPC22P	24	PFLX18	20	UGPWB2014	26
15SVSTCP	23	FLX45P	15	NPC28	16	PFLX19	20	UGPWB2514	26
15TKP	12, 22	FLX47	15	PC15B	16	PFLX22	20	UGPWB2516	26
15WB	12	FLX48	15	PC15R	16	PFLX37	20	UGSTV2020	26
15WB2	12	FLX49	15	PC15W	16	PFLX37-H	20	UGSTV2515	26
15WBP	22	FLX53	15	PC22B	16	PFLX78	20	UGSTV2522	26
22EPR	16	JG-BS10	14	PC22R	16	PFLX88	20	UGSTV2525	26
22BLKCON-25C	15	JG-BS15	14	PC22W	16	PKM1910B	18	UGSTV3232	26
22BLKCON-50C	15	JG-BS22	14	PC28B	16	PKM1910R	18	UTS147-DB	26
22BLUCON-50C	15	JG-FOP	14	PC28R	16	PKM1910W	18	UTS197-DB	26
22BPB-25C	15	JG-STAND/BM	18	PC28W	16	PL10	14	UTS251-DB	26
22BPB-50C	15	JG-STAND/C	17	PCSW	16	PL15	14	WFLX15	18
22BPEX-20X2L	15, 24	JG-STAND/DG	17	PEM0210W	11	PL22	14	WFLX16	18
22BPEX-20X3L	15, 24	JG-STAND/FLEXI	17	PEM0210WP	21	PL28	14	WFLX17	18
22BPEX-20X6L	15	JG-STAND/P	18	PEM0215W	11	PM1915B	18	WFLX18	18
22BPEX-25C	15, 24	JG-STAND/UG2	18	PEM0215WP	21	PM1915R	18	WFLX19	18
22BPEX-50C	15, 24	JG-STAND/WFLEXI	17	PEM0222W	11	PM1922B	18	WFLX20	18
22BPEX20X6L-B	15	JG-TS	16, 24	PEM0222WP	21	PM1922R	18	WFLX21	18
22BPEX20X6L-R	15	JGBR	35	PEM0228W	11	PSE3201W	13	WFLX22	18
22BV	14	JGCO	35	PEM0228WP	21	PSE3201WP	24	WFLX28	18
22BVP	24	JGCONTROL/4	34	PEM0310W	9	PSE3202W	13	WFLX29	18
22CFA	13	JGHD	16	PEM0310WP	19	PSE3202WP	24	WFLX33	18
22CFAP	22	JGHUB1	35	PEM0315W	9	PSE3203W	13	WFLX36	18
22CFB	16	JGHUB2	35	PEM0315WP	19	PSE3203WP	24	WFLX-37H	18
22CMA	13	JGMA2	14	PEM0322W	9	PSE3210W	13	WFLX39-H	18
22CMA	22	JGMA3	14	PEM0322WP	19	PSE3210WP	24	WFLX40	18
22HSV	14	JGMA4	14	PEM0328W	9	PSE4610W	14	WFLX51	18
22HSVP	23	JGPRB	36	PEM0328WP	19	PSE4610WP	23		
22MC(3/4)	13	JGRAD15	14	PEM0410W	9	PSE4615W	14		
22MC(3/4)P	22	JGROOMPACK/2	37	PEM0410WP	19	PSE4615WP	23		
22PIP-50C-E	15	JGSB	36	PEM0415W	9	PSE4622W	14		

GENERAL CONDITIONS OF SALE

1. GENERAL

(a) These conditions and any special conditions agreed in writing between us and the purchaser shall apply to all by us and all orders and contracts for the manufacture or sale of goods accepted or carried out by us to the exclusion of any conditions in the purchaser's order terms or otherwise imposed by the purchaser.

(b) All orders are subject to our written acceptance and in particular no binding contracts shall be created by the acceptance by the purchaser of a quotation or offer made by us unless and until we shall have accepted the order in writing.

2. DOCUMENTS

(a) Unless otherwise stipulated in our written acceptance all descriptions, illustrations, drawings in our catalogues and literature (copies of which are available on request) or submitted independently, estimates of performance, weights and measurements or other specifications provided by us are approximate only and we reserve the right to alter or amend the same at any time.

(b) We reserve the right at any time to correct clerical or technical errors in the contract documents.

(c) The purchaser shall furnish with his order all necessary specifications and information. We take no responsibility for goods manufactured, priced or delivered not in accordance with the order or the specifications unless the purchaser's order and specifications are clear and correct in every particular.

3. ADVISORY SERVICE

The advisory service which we provide in connection with our goods is part of our sales service and we do not make any charge for advice given. Any advice and assistance is given at the purchaser's risk and we shall not be liable for any loss, damage or claims arising therefrom.

4. HEALTH AND SAFETY AT WORK ACT

The purchaser's attention is drawn to the installation, maintenance and operating instructions given in our catalogues or literature. These should be carefully followed. Further information if required is available at our Head Office.

5. PRICES

(a) Unless otherwise stipulated all prices contained in our quotations and written acceptances are ex works and do not include the cost of packing. All orders are accepted on the condition that all such prices are subject to revision by us at any time before the goods are dispatched to take account of any increase in costs.

(b) In the event of the whole order quoted for not being placed with us we reserve the right to revise our prices.

(c) We also reserve the right to revise our prices if any changes are made by the purchaser in the specifications or quantities of the goods or delivery requirements after the order has been accepted.

6. VALUE ADDED TAX

VAT if not included in our quotation shall be added and payable where and at the rate applicable.

7. MINIMUM CHARGE

Depending on the product or service provided, a minimum order charge may be applicable. Details of these charges are as shown on current price lists or quotations or are available from the Customer Services Department.

8. TERMS OF PAYMENT

(a) Unless otherwise stipulated in our written acceptance our terms of payment are 30 days from date of invoice.

(b) Overseas business is accepted subject to special terms as to payment to be agreed prior to our written acceptance of the order.

(c) Where the contract is to be or may be fulfilled in separate installments, deliveries or part payment for each such installment delivery or part shall be made under sub-clause (a) above as if the same constituted a separate contract.

(d) We shall be entitled to interest on all sums overdue at the rate of two and one half percent above our bank's base rate from time to time in force.

(e) In the event of the purchaser for any reason whatsoever failing within one calendar month of the due date for payment to effect any payment which may be due under the contract or any contract with us, or if he commits any breach of the contract, or if he becomes insolvent or commits any act of bankruptcy or calls a meeting of or enters into a competition with or for the benefit of his creditors, or being a body corporate, has a receiver appointed of its undertaking or assets or any part thereof or a winding up order is made against the purchaser or the purchaser goes into liquidation (save for the purpose or reconstruction or amalgamation), we shall thereupon be entitled, without prejudice to our other rights, forthwith to terminate the contract or any unfulfilled part thereof, or at our option to make partial deliveries.

9. CANCELLATION

No order or other contract may be cancelled or varied except by agreement in writing with us, and on such terms as we may stipulate.

10. HANDLING CHARGE

Goods supplied in accordance with the purchaser's order may later be returned to us at our discretion provided the goods are unused. The purchaser will be required to pay to us a handling charge of 15% to 30% of the then current list price of such returned goods, dependent on the condition of the goods.

11. TIME FOR DESPATCH

(a) All periods or dates quoted for despatch and delivery are approximate only.

(b) We shall be entitled, without liability on our part and without prejudice to our other rights, to terminate the contract or any unfulfilled part thereof, or at our option to suspend or make partial deliveries if the completion or the manufacture of the goods by us or by our suppliers is prevented, hindered or delayed whether directly or indirectly by reason of the purchaser failing to furnish necessary information or instructions, or of any strikes, lock-outs, fire, flood, accident or damage to goods or delay in obtaining or inability to obtain through scarcity of materials, or any other cause whatsoever beyond our or our suppliers' reasonable control, whether such cause exists at the date of the order or not.

12. DELIVERY AND RISK IN GOODS

(a) Unless otherwise expressly agreed in writing, or as otherwise herein provided, delivery of the goods shall be deemed to be made when we have notified the purchaser that the goods are ready for despatch from our works and the risk in the goods shall thereupon pass to the purchaser. We shall not in any event be under any obligation to give to the purchaser the notice specified in Section 32 (3) of the Sale of Goods Act 1979.

(b) Notwithstanding that our prices are ex works we are prepared by special contract to procure carriage or freight and insurance on behalf of the purchaser and at his cost in which event we shall be under no liability for damage in transit loss or damage to the goods beyond the point of which we contract to deliver the same.

(c) The following provisions shall apply in relation to all deliveries of goods.

(i) we will entertain no claim for damage in transit, shortage of delivery or loss of goods, unless in the case of damage in transit or shortage of delivery a separate notice in writing is given to the carrier concerned and to us within three days of the receipt of the goods, followed by a complete claim in writing within five days of receipt of the goods and in the case of loss of goods, a separate notice in writing is given to the carrier concerned and to us and a complete claim in writing made within thirty days of the date of consignment;

(ii) where goods are accepted from the carrier concerned without being checked the delivery book of the carrier concerned must be signed 'not examined';

(iii) we shall have the right to attend at the purchaser's premises to inspect any goods in respect of which any such claim is made and the purchaser shall retain such goods until we shall have inspected such goods or until we have notified the purchaser that we do not wish to inspect such goods;

(iv) any breach of this condition shall dis-entitle the purchaser to any allowance in respect of the claim.

(d) Without prejudice to our other rights, should the purchaser fail for any reason to send us forwarding instructions within ninety days after the date of our notification that the goods are ready for despatch or to accept delivery of the goods we shall be entitled at the purchaser's risk and expense to store the goods and/or to procure or effect storage of the goods elsewhere. Goods so stored shall be paid for as if they had been dispatched and/or accepted.

13. PROPERTY IN THE GOODS

Until further payment has been received by us for all goods whatsoever supplied at any time by us to the purchaser:

(a) Property in the goods shall remain in us.

(b) Subject to sub-clauses (c) and (d) below the purchaser shall be at liberty to sell the goods in the ordinary course of business on the basis that the proceeds of sale shall be our property and that the purchaser shall account to us on demand.

(c) We may at any time revoke the purchaser's power of sale by notice to the purchaser if the purchaser is in default for longer than seven days in the payment of any sum whatsoever due to us or if we have bona fide doubts as to the solvency of the purchaser.

(d) The purchaser's power of sale shall automatically cease if the purchaser becomes insolvent or commits any act of bankruptcy or calls a meeting of or enters into composition or arrangement with or for the benefit of his creditors, or being a body corporate has a receiver appointed of its undertaking or assets or any part thereof or a winding-up order is made against the purchaser or the purchaser goes into liquidation (save for the purposes of reconstruction or amalgamation).

(e) Upon determination of the purchaser's power of sale under sub-clause (c) or (d) above the purchaser shall place the goods at our disposal and we shall be entitled to enter any premises of the purchaser for the purpose of removing such goods from the premises.

14. SPECIAL TOOLS OR DIES

Where it is necessary for us to manufacture or to purchase special tools, dies, jigs, mandrills in order to execute a contract the purchaser will be charged with a proportion of the cost of such special tools. Any such tools remain our property even when the purchaser has been charged with part of the cost.

15. TEST AND PERFORMANCE

(a) Our goods are, where practicable, submitted to our standard test before delivery. If special tests are required, these shall be made at our premises unless otherwise agreed, and will be charged extra.

(b) We accept no liability for failure to attain any performance figures quoted by us unless we shall have specifically guaranteed them with an agreed sum as liquidated damages and the purchaser has suffered loss by reason of the failure to attain the figures quoted.

(c) Any particulars of weights and measurements, power and consumption, power output or performance relating to the goods and like matters furnished by us to the purchaser in our catalogues, literature or otherwise, are approximate and are intended only to present a general idea of the goods to be supplied and unless previously agreed specifically in writing shall not form part of the contract.

16. FAULTS AND DEFECTS AND EXCLUSION OF LIABILITY

(a) We warrant that if within twelve months of delivery of the goods to the purchaser the purchaser returns immediately to our premises any of the said goods which he considers to be defective, carriage paid, properly packed and clearly marked with the purchaser's full name and address and any other information such as serial numbers which may be necessary to enable the goods to be identified, together with a complete description of the respects in which it is alleged that the goods are defective, such goods will be examined and should we be satisfied that the goods are defective, they will be repaired or new goods will be supplied in exchange and the goods so repaired or such new goods will be delivered to the purchaser free of charge at our premises provided that the foregoing warranty shall only be applicable if upon being required by us to do so the purchaser proves to our satisfaction:

(i) that the defect was due solely to defective workmanship;

(ii) that no alterations or repairs have been made to the goods except with our written consent;

(iii) that the defect was not caused by incorrect or negligent handling or storage, disregard of operating instructions, over-loading, unsuitable work, faulty erection or any other default by the purchaser, his servants or agents;

(iv) that the defect was not caused by fair wear and tear, accident, or any other matter beyond our reasonable control occurring after the date of receipt by the purchaser.

(b) All costs and expenses, including freight charges, customs duties and insurance costs incurred in returning the goods to our premises in accordance with this condition shall be for the account of the purchaser. The benefit of this warranty shall not be assignable by the purchaser.

(c) The warranty contained in sub-paragraph (a) above does not extend to any goods not manufactured by us although supplied by us nor does it extend to any second-hand or reconditioned goods. Goods not manufactured by us carry only the warranty (if any) of the makers and the purchaser is entitled to the benefit thereof only so far as we have the power to transfer it.

(d) The terms of this condition are in lieu of all conditions, warranties or other terms as to description, fitness for purpose, condition, merchantability, quality or otherwise in respect of the goods or repaired or replacement goods whether expressed in the contract or implied by common law, custom or statute and notwithstanding that such purpose or condition may be, may become or may have been known to us. Apart from our obligation to repair or replace goods in accordance with the terms of this condition, we accept no liability in respect of the goods whether for consequential loss or loss of profits or damages to third parties or otherwise, to the extent permitted by law.

17. INDEMNITY

The purchaser shall indemnify us against all actions, claims, demands, penalties and costs by third parties in tort, or for infringement, or alleged infringement, of patents, registered designs or other industrial property rights, or otherwise arising, in connection with the goods or with their delivery or unloading or with work done by us on the goods manufactured in accordance with the purchaser's specifications.

18. LIEN

In addition to any right of lien to which we may by law be entitled we shall have a general lien on all goods of the purchaser in our possession (although such goods or some of them may have been paid for) for the unpaid price of any other goods sold and delivered to the purchaser by us under the same or other contracts.

19. WAIVER

Our rights shall not be affected or restricted by any indulgence or forbearance granted to the purchaser. No waiver by us of any breach shall operate as a waiver of any later breach.

20. LAW AND JURISDICTION

The rights and obligations of the parties and all the terms and conditions thereof any disputes arising out thereof shall be construed in accordance with English Law to the jurisdiction of the courts of which the purchaser shall submit.

21. GENERAL

If any of these conditions or any part thereof:

(i) purports to exclude or restrict or limit any liability and such exclusion or restriction or limitation is prohibited or rendered void or unenforceable by any legislation to which it is subject;

(ii) is itself prohibited or rendered void or unenforceable by any legislation to which it is subject;

then the exclusion restriction or limitation on the condition or part thereof in question shall be so prohibited or rendered void or unenforceable to the extent to which it is prohibited or rendered void or unenforceable and no further and the validity or enforceability or any other part of these conditions shall not thereby be affected.

John Guest Speedfit Limited

Horton Road, West Drayton, Middlesex UB7 8JL, England.
Tel: (00 44) (0) 1895 449233 Fax: 01895 420321. speedfit.co.uk
Technical Help Desk: 01895 425333



John Guest fittings and related products are specifically designed and manufactured by John Guest to the Technical Specifications set out in the John Guest Product Catalogues. All John Guest fittings and related products should be selected, installed, used and maintained in accordance with these Technical Specifications. It is the customer's / user's responsibility to ensure that John Guest fittings and related products are suitable for their intended applications, are properly installed and maintained and are used in accordance with the Technical Specifications. It is also the customer's / user's responsibility to provide it's own customers with any relevant technical information about John Guest products it supplies them.

Speedfit should not be used for gas, fuel oil or compressed air applications.

John Guest produce a push fit system of pipe and fittings for compressed air situations. See separate literature for details.

The company has a policy of continuous research and development and reserves the right to amend without notice the specification and design of all products illustrated in this catalogue. John Guest Speedfit reserve the right to change the colour and shape of products. Photographs are for illustration purposes only.

Subject to our Terms and Conditions of Sale shown on page 41.

JG: John Guest®, *Speedfit*® and *JG Layflat*® are registered trademarks of John Guest International Limited © Copyright 2017.

AVAILABLE FROM: